

PATLITE®

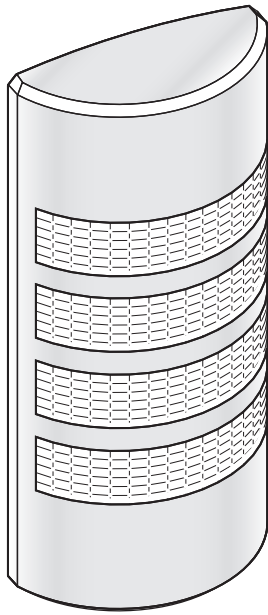

Notice to Customer

Thank you very much for purchasing our PATLITE product.

- Request the installation and wiring be performed by a professional contractor if construction work is involved.
- Prior to installation, read this manual thoroughly before using this product to ensure correct use.
- Re-read this manual before conducting maintenance, inspections, repairs, and so on.

If you have any questions about this product, please contact the service and repair desk listed on the website.

- Before using this product, update to the latest version of the firmware.

By registering as a member on our home page, you can download the latest version of the firmware from My Page.

To the Contractor

- Prior to installation, read this manual thoroughly to ensure it is installed correctly.
- Return this manual to the customer.

Wall mount Signal Tower

TYPE WE-402UB-LAN

Instruction Manual

[Web Version]

	<i>page</i>
1. Before You Begin	5
2. Models	10
3. Contents	10
4. Part Names and Dimensions	11
5. Product Features and Functions	12
6. Mounting, Installation, Wiring, and Powering on	16
7. Before Use	21
8. How to Use	36
9. Maintenance	66
10. Troubleshooting	73
11. Replacement Parts	75
12. Specifications	76

Table of Contents

1. Before You Begin	5
1.1. About Safety Symbols	5
1.2. Safety Precautions	6
1.3. Laws and regulations of each country	8
1.4. Trademarks	9
1.5. Network Security	9
2. Models	10
3. Contents	10
4. Part Names and Dimensions	11
5. Product Features and Functions	12
5.1. Product Features	12
5.1.1. Product Features	12
5.1.2. Multilingual Support	12
5.2. Product Functions	13
5.2.1. Signal Tower and Buzzer Notification Functions	13
5.2.2. Communication Command Control Function	15
6. Mounting, Installation, Wiring, and Powering on	16
6.1. Mounting Method	17
6.2. How to Remove the Cover After Installation	18
6.3. Wiring Method	19
6.4. Checking at Startup	20
7. Before Use	21
7.1. Setting Up Network Settings on the PC	22
7.2. Setting Up the Password	25
7.3. Displaying the Web Setup Screen	27
7.4. Setting Up Product Network Settings	29
7.5. Setting Up Main Unit	30
7.6. Setting Up Command Reception Settings	31
7.7. Setting up Modbus/TCP	32
7.8. Reading the Setup Data	33
7.9. Writing the Setup Data	34

7.10. How to logout from the Web setup screen	35
8. How to Use	36
8.1. PNS Commands	36
8.1.1. Signal Tower Motion Control Commands	37
8.1.2. Detailed Motion Control (All-tiers Flashing) Command	38
8.1.3. Detailed Motion Control (Flashing Individual) Commands	40
8.1.4. Clear Command	42
8.1.5. Get Status Command	42
8.1.6. Get Status Details Command	44
8.1.7. Buzzer Volume Setting Command	47
8.2. Modbus/TCP	48
8.2.1. Function Code	48
8.2.2. Register Address	49
8.2.3. Example Mapping of Registers	52
8.2.4. Example Transmission	53
8.3. HTTP Commands	57
8.3.1. Controls HTTP Command	58
8.3.1.1. "alert" control	59
8.3.1.2. "color" control	59
8.3.1.3. "buzzer" control	60
8.3.1.4. "flash" control	60
8.3.1.5. "flashe" control	61
8.3.1.6. "clear" control	61
8.3.1.7. Example Transmission	62
8.3.2. Get HTTP command status	63
9. Maintenance	66
9.1. Initialization Method	66
9.1.1. How to Initialize with the "Switch for Initialize"	66
9.1.2. Initialize from the Web Setup Screen	67
9.2. Restarting Method	69
9.3. How to change Web Login Password	70
9.4. How to check the Version	71



9.5. How to update the Firmware	72
10. Troubleshooting	73
10.1. Troubleshooting	73
11. Replacement Parts	75
12. Specifications	76

1. Before You Begin



1.1. About Safety Symbols

To prevent injuries to the user and other personnel, as well as to prevent damage to assets, note the following:



- The following symbols classify warnings and cautions, and describe the level of harm and damage that will occur when the corresponding instructions are ignored.

 WARNING	This symbol indicates, "Failure to follow the instructions may lead to death or serious injury."
 CAUTION	This symbol indicates, "Failure to follow the instructions may lead to injury or property damage."



- The following symbols classify and describe the content of associated messages.

 Prohibited	This symbol identifies "Prohibited" operations that should never be carried out.
 Mandatory	This symbol identifies "Mandatory" instructions that should always be carried out.
	This symbol identifies general "Caution" related information.

1.2. Safety Precautions

 WARNING	
 Prohibited	<ul style="list-style-type: none"> ● Do not modify or disassemble this product. Failure to follow this instruction could result in fire or electric shock. ● Do not use this product when there is condensation. Failure to follow this instruction could result in fire or electric shock. ● Do not apply voltage that exceeds the acceptable range. If you apply more than the rated voltage, internal circuits will be damaged. Failure to follow this instruction could result in fire or electric shock. ● This product is not intended for use in facilities or equipment that require a high degree of reliability and which may affect human life, either directly or indirectly. We cannot be held responsible in the event of injury, death, or property damage that may result in the use of this product in facilities, equipment, or control systems.
 Mandatory	<ul style="list-style-type: none"> ● Observe the following to prevent short-circuits, electric shock, and damage: <ul style="list-style-type: none"> · Turn off the power before wiring or repairs, including replacement of the fuse. · Install the product correctly. (Do not leave the cover off. Do not use with the cover off.) ● If installing this product requires construction, have the work done by a professional contractor. Failure to follow this instruction may result in electric shock, fire, or falling objects. ● To prevent , injuries and property damage that could result from product failure or malfunction, ensure sufficient safety by using this product together with other equipment. ● When using this product for the purpose of maintaining safety, inspect it daily. Use this product with other equipment in the unlikely event of product failure or malfunction. ● After installation, do not use this product to climb up onto equipment. Failure to follow this instruction will result in product damage and/or falling off the machinery. ● If an unusual condition occurs while using this product, such as emitting smoke, heat, abnormal odor, or unusual sound, stop the application, disconnect the power, and contact your nearest PATLITE Sales Representative. ● To prevent accidents when operating or maintaining the product, in addition to the safety guidelines identified in the instructions of this manual, follow all general safety guidelines. We cannot foresee all circumstances concerning the handling and dangers associated with this product. Therefore, not every possible danger is indicated in this instruction manual.

 **CAUTION**

<p> Prohibited</p>	<ul style="list-style-type: none"> ● Do not use in locations near fire or environments with high temperature and humidity. Do not use this product where corrosive, flammable gas is present. ● Do not use this product if liquids (such as water or chemicals) or foreign metallic objects (such as copper wire) have entered this product. Failure to follow this instruction could result in product damage. ● Don't use it near equipment (solenoid and so on.) or wires which creates strong electric or magnetic fields. Failure to follow this instruction could result in malfunction due to inductive noise. ● Do not use this product near chemicals. This product could melt or become deformed if any chemicals adhere to it. ● Do not use excessive force on this product. Failure to follow this instruction could result in deformed frame and product damage. ● Do not use sharp tipped objects with this product. Operation may become impossible as scratches develop on buttons and contacts are interfered with. ● Avoid exposure to the buzzer sound from a close distance. Failure to follow this instruction will result in injury (hearing loss). ● For the purpose of safety, insert a fuse on the power supply side to protect external devices as shown in "6.3 Wiring Method". ● Do not bend the power supply wire or LAN cable unnecessarily. Failure to follow this instruction could result in disconnection and malfunction or equipment damage. ● When packing or unpacking equipment that the product is attached to, be careful not to snag the product. Failure to follow this instruction may result in equipment damage. ● Do not wipe dirt on this product with thinners, benzine, gasoline, oil, chemicals, and so on. Failure to follow this instruction could result in discoloration and deterioration. Wipe with a soft cloth, dampened with water and wrung tightly.
<p> Mandatory</p>	<ul style="list-style-type: none"> ● Before handling static-sensitive parts of this product, discharge any static electricity from the body. (To prevent damage from static electricity, place your hand or other body part onto a metal object or to an earth ground.) ● Use only the specified replacement parts listed in this manual.

1.3. Laws and regulations of each country

● For Customers in U.S.A.

This equipment has been tested and found to comply with the limits for a Class A digital device, pursuant to Part 15 of the FCC Rules.

These limits are designed to provide reasonable protection against harmful interference when the equipment is operated in a commercial environment.

The equipment generates, uses, and can radiate radio frequency energy and, if not installed and used in accordance with the instruction manual, may cause harmful interference to radio communications.

Operation of this equipment in a residential area is likely to cause harmful interference in which case the user will be required to correct the interference at his own expense.

(Responsible party in U.S.A.) 20130 S. Western Ave. Torrance, CA90501, U.S.A.

● For Customers in Europe

This product has been tested and found to comply with the limits for a Class A device.

These limits are designed to provide reasonable protection against harmful interference when the equipment is operated in a commercial environment.

This product must not be used in residential areas.

● Für Kunden in Europa

Dieses Produkt wurde geprüft und hält die Grenzwerte für ein Klasse-A-Gerät gemäß.

Diese Grenzwerte sind so ausgelegt, einen angemessenen Schutz gegen schädliche Störungen zu gewährleisten, wenn das Produkt in einer geschäftlichen Umgebung verwendet wird. Dieses Produkt darf nicht in Wohngebieten verwendet werden.

● Pour les clients en Europe

Cet appareil a été testé et jugé conforme aux limites définies pour les appareils de

classe A. Ces limites sont conçues pour fournir une protection raisonnable contre les interférences nuisibles lorsque

l'équipement est utilisé dans un environnement commercial. Ce produit ne doit pas être utilisé dans une zone résidentielle.

● Per i clienti in Europa

Questo prodotto è stato testato ed è risultato conforme ai limiti per un apparecchio di Classe A. Questi limiti sono progettati per fornire una protezione ragionevole contro interferenze dannose quando l'apparecchiatura viene utilizzata in un ambiente commerciale. Questo prodotto non deve essere usato in aree residenziali.

● Para clientes en Europa

Este producto ha sido sometido a pruebas y se ha determinado que cumple con los límites para un dispositivo de clase A.

Estos límites están diseñados para proporcionar una protección razonable contra interferencias perjudiciales cuando el equipo se opera en un entorno comercial. Este producto no debe ser utilizado en áreas residenciales.

1.4. Trademarks

- Microsoft Edge and Internet Explorer are registered trademarks of Microsoft Corporation in the United States and other countries.
- Google Chrome is a trademark or registered trademark of Google LLC.
- Other company and product names that are used are the registered trademarks or trademarks of those respective companies.

1.5. Network Security

The user is responsible for the network security of this product and its use.

Take appropriate network security measures to avoid security breaches.

- Use this unit in a network secured by a firewall, etc.
- Change the login password periodically.
- Save user authentication information (user names and passwords) in such a way that it is kept out of the hands of third parties

This product cannot connect directly to the Internet.

When connecting this product to the Internet, use a router or similar device.

2. Models

	Model		Number of Signal Tower Tiers	Rated Voltage	Cover Color	Buzzer		Communication Method
Model Number	WE	-	4	02	U	B	-	LAN

↑

4

4 Tier

↑

02

24V DC

↑

U

Silver

↑

B

Buzzer

↑

LAN

LAN Communication

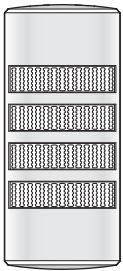

3. Contents

Main Unit: 1

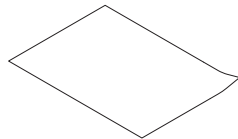

Installation manual: 1

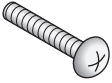

Accessories					
Screw (+ Pan head screw)		Plain Washer		Nut with Flange	
Size	M4 x 25	Size	φ 4 x 8 x 0.5	Size	M4
Material	Steel	Material	Steel	Material	Steel
 x 4		 x 4		 x 4	

(Unit: mm)

4. Part Names and Dimensions

● Cover

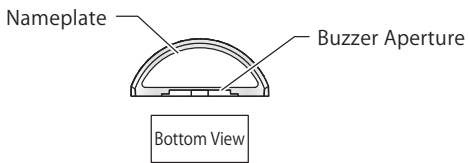
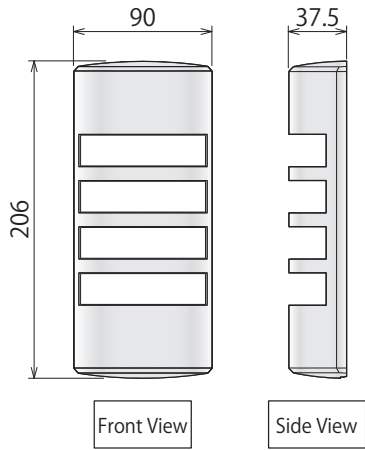

● Main Unit

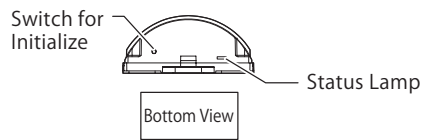
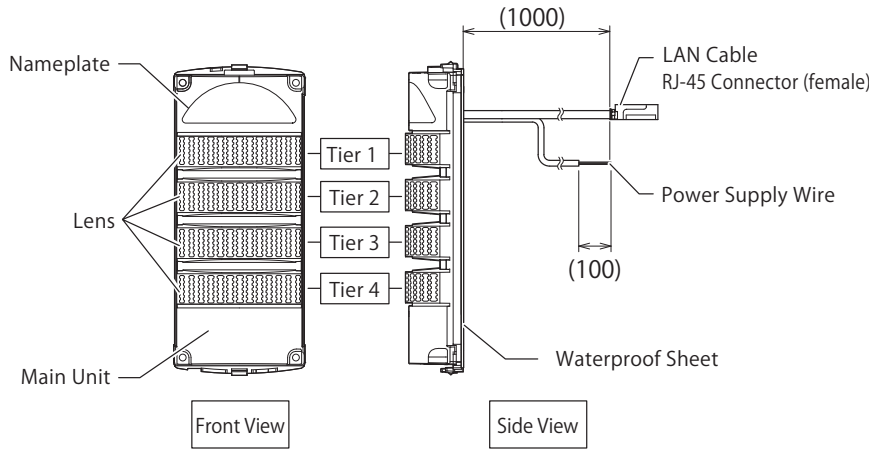

(Unit: mm)

5. Product Features and Functions

5.1. Product Features

5.1.1. Product Features

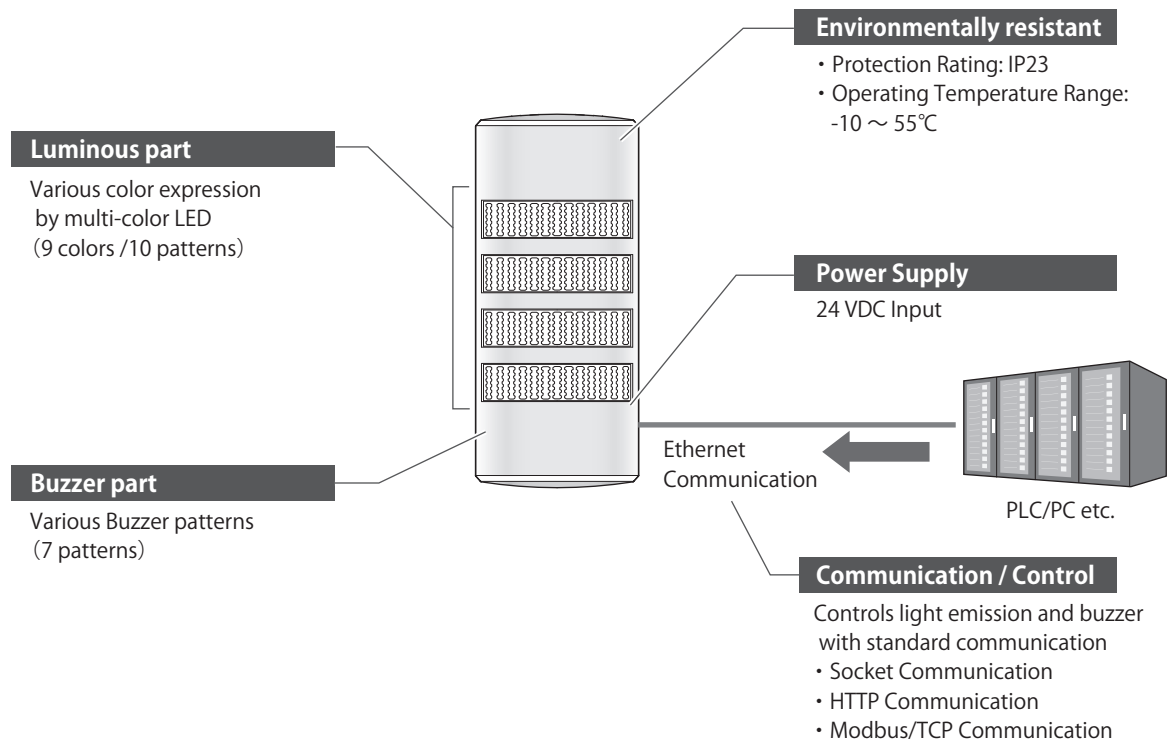

5.1.2. Multilingual Support

You can work with the Web Setup Screen in multiple supported languages.



Supported languages

Japanese, English

5.2. Product Functions

This section describes the functions of this product.

5.2.1. Signal Tower and Buzzer Notification Functions

- You can turn on, turn off or flash the Signal Tower, or emit a buzzer in response to events.
- The following indicates a list of operations for each pattern.

● Signal Tower pattern list

No flashing



Flashing (slow)



Flashing (medium)



Flashing (fast)



Single flash



Double flash



Triple flash

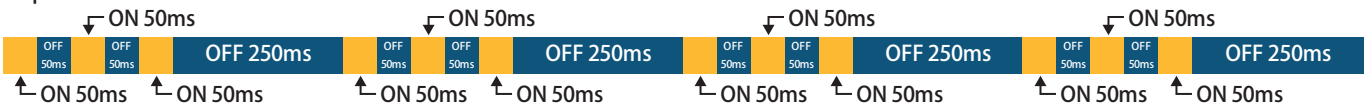

Pulse (bright and dark)



Right Chase Light

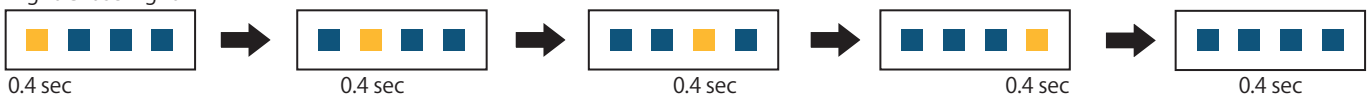

Left Chase Light

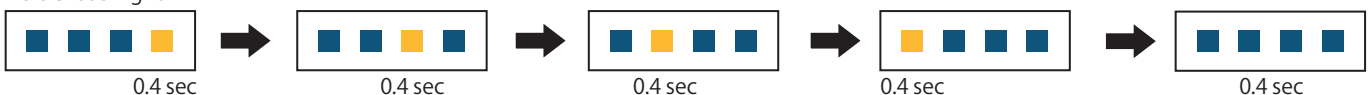

● Buzzer pattern list

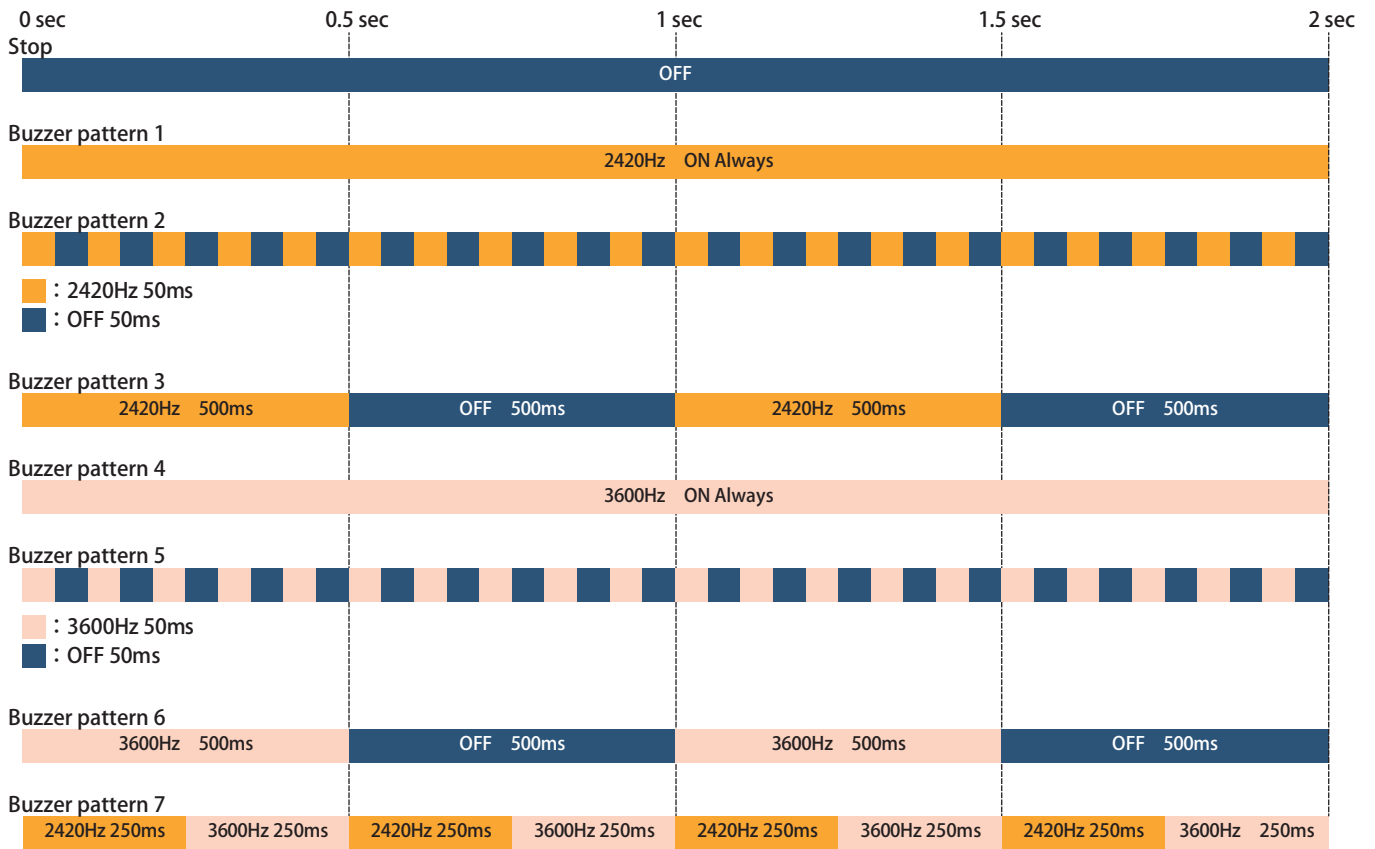

5.2.2. Communication Command Control Function

You can use various commands to control light or buzzer of Signal Tower and send notifications. Following commands can be executed in each communication.

● Socket communication

Command	Overview
Signal Tower motion control	<ul style="list-style-type: none"> Controls tiers 1 to 4 Signal Tower by command with colors set on the Web screen. Controls the buzzer with commands.
Detailed motion control (flashing all tiers)	<ul style="list-style-type: none"> All tiers are controlled by specifying color for the tier 1 to 4 of Signal Tower with commands. Controls the buzzer with commands.
Detailed motion control (flashing individual)	The color of the tier 1 to 4 of the Signal Tower is specified by command, and controls each tier individually. <ul style="list-style-type: none"> Controls the buzzer with commands.
Clear	Turns off the Signal Tower and stops the buzzer.
Get Status	Gets the status of this product.
Get Status Details	Gets details about the status of this product, including color information.
Buzzer volume setting	Set up the volume to play the buzzer.

● Modbus/TCP communication

Function Name	Overview
Read Holding Registers	Gets the current state of the Signal Tower and buzzer.
Write Single Register	Changes 1 data in the Data Address Register, and control the Signal Tower and buzzer.
Diagnostics	Gets the power status of this product.
Write Multiple Registers	Changes multiple data in the Data Address Register, and control the Signal Tower and buzzer.

● HTTP communication

Parameter Name	Overview
alert	Controls each tier of the Signal Tower and buzzer.
color	Controls the Signal Tower by specifying the color of each tier. (Make sure to specify "buzzer" at the same time)
buzzer	Emits buzzer by specifying the buzzer pattern. (Make sure to specify "color" at the same time)
flash	Controls all tiers of the Signal Tower. (Specify both "color" and "buzzer" at the same time)
flashe	Controls each tier of the Signal Tower. (Specify both "color" and "buzzer" at the same time)
clear	Turns off the Signal Tower and stops the buzzer.
format	Obtains Signal Tower and buzzer status, software version, and MAC address in a specified format.

6. Mounting, Installation, Wiring, and Powering on



CAUTION

- ❗ Install a location with low vibration and sufficient strength.
- ⚠ This product can only be mounted in upright position.
- ⚠ Use this product indoors only. (Do not use outdoors.)
- ❗ If the cover cracks or the plating peels off due to a strong impact such as dropping the product, the damaged part becomes sharp and very dangerous. If the product becomes damaged, do not continue using it and immediately replace it.
- ❗ During installation, do not remove the waterproof sheet. Doing so will hinder waterproofing. (Protection Rating: IP23)
- ❗ When increased waterproofing is required, seal the screw or flanged nut parts, as well as over the waterproof sheet around the mounting hole, with a waterproof sealant.
- ❗ If increased waterproofing is required on an uneven mounting surface, in addition to the screw or flanged nut parts, seal the gap between the product and the mounting surface with a waterproof sealant.

6.1. Mounting Method

1 In the mounting location, drill holes for mounting and wiring the product.

2 Remove the cover from the main unit.

- If it is difficult to remove the cover, wear work gloves before starting.
- Do not apply excessive force to the cover or lens. Failure to follow this instruction could result in equipment damage.

3 Pass the LAN cable and power cable through the wire entry hole.

4 Mount the main unit on the wall.

- When mounting the main unit on the wall, pass the cable through the wire entry hole so that the LAN cable and power line do not get caught. (Affix with the 4 screws provided.)

Recommended Torque
0.6N·m

5 Attach the cover to the main unit.

- Attach the cover after hooking the recess of the cover over the protrusion on the main unit.

<Product Installation Diagram (Upright)>

Install the product upright so that the **Buzzer Aperture** facing downward.

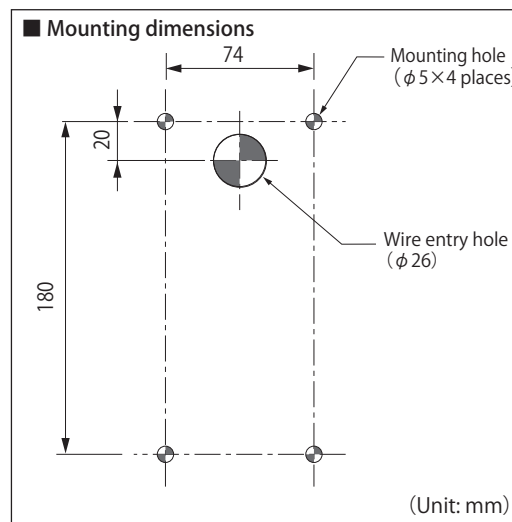
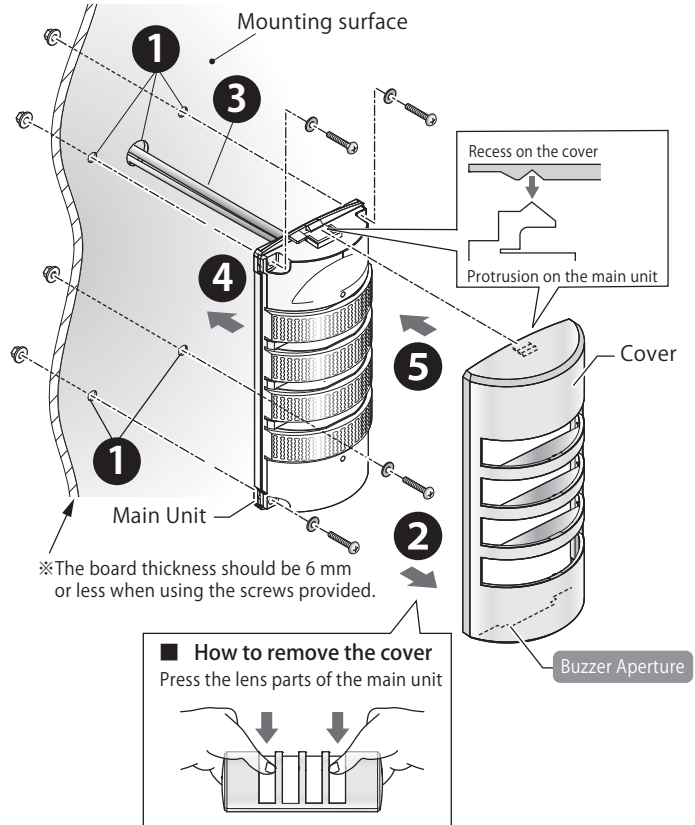

6.2. How to Remove the Cover After Installation

1

Insert a flathead screwdriver into the "removal groove" of the buzzer aperture.

- Recommended tip width of flathead screwdriver: 6 mm

2

Turn the flathead screwdriver counterclockwise to release the claws.

- * The flathead screwdriver could damage the mounting surface or cover. Use with care.

3

Lift the cover and remove.

- * Use a flathead screwdriver to remove the cover. Forcibly removing the cover by hand may result in injury.

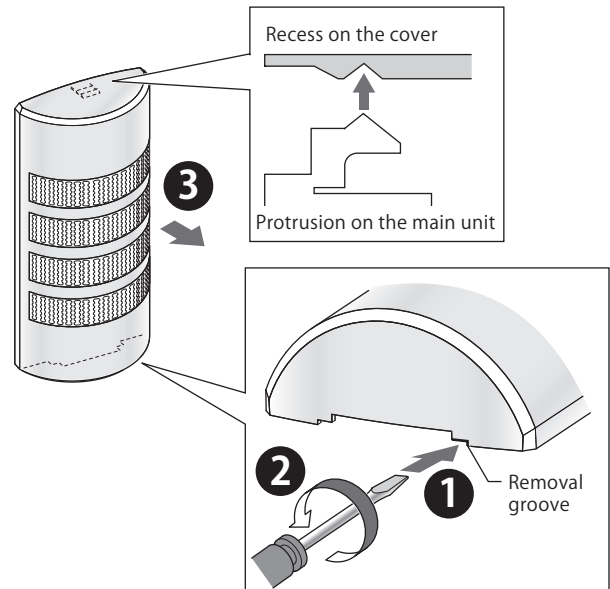

6.3. Wiring Method

⚠ CAUTION

Please read the following carefully when wiring the power supply wires.

- ❗ Turn OFF the power before wiring. A short circuit may damage internal circuits or cause an electric shock.
- ❗ Pay close attention to the wiring to avoid mistakes. Incorrect wiring will burn out internal circuits.
- ❗ As shown in the wiring example, be sure to insert a fuse on the power supply side for external equipment protection. It will protect the power supply from burnout in case of a wiring error.

Please read the following carefully when wiring LAN cables.

- ❗ Confirm that the network is indoors and the LAN cable is not routed outdoors. Failure to follow this instruction could result in equipment damage due to transient voltage from lightning.
- ❗ The LAN cable should have an RJ-45 connector and be rated for Category 5e or higher (Category 6 or higher recommended). (You can use either a straight through or crossover cable.)
- ⊘ When wiring, do not tug the power supply wires, LAN cable, or RJ45 connector, nor stuff them into the main unit.

● Wiring Example

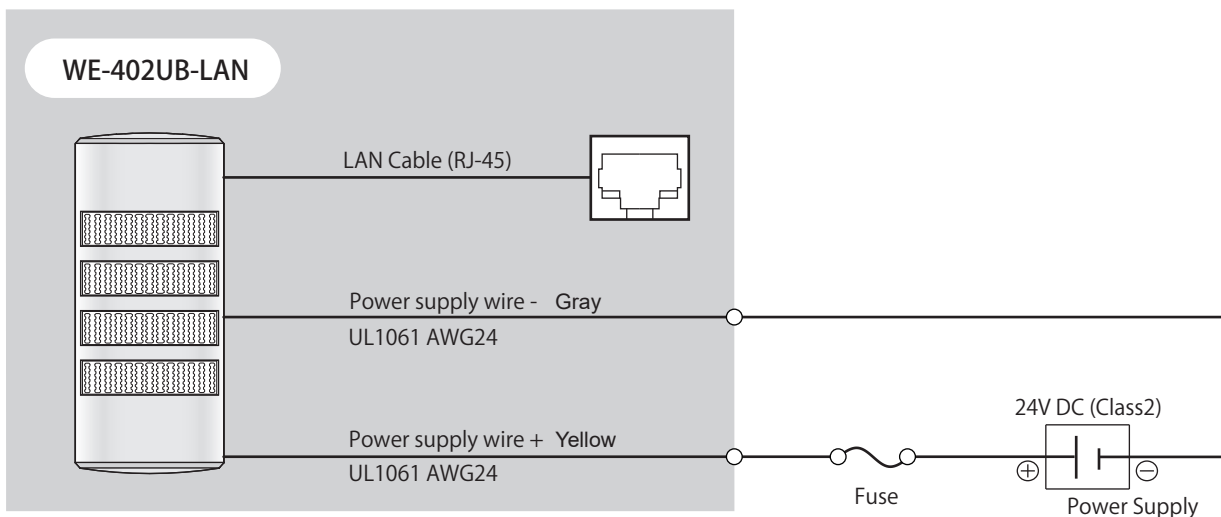

● Fuse

Rated Current of Fuse	250 V / 1 A
-----------------------	-------------

* Recommended Fuse : 250 V/1 A (5 X 20mm Fast-Acting Glass Body Cartridge Fuse)

6.4. Checking at Startup

Remove the cover and check the status light on the bottom of the product.

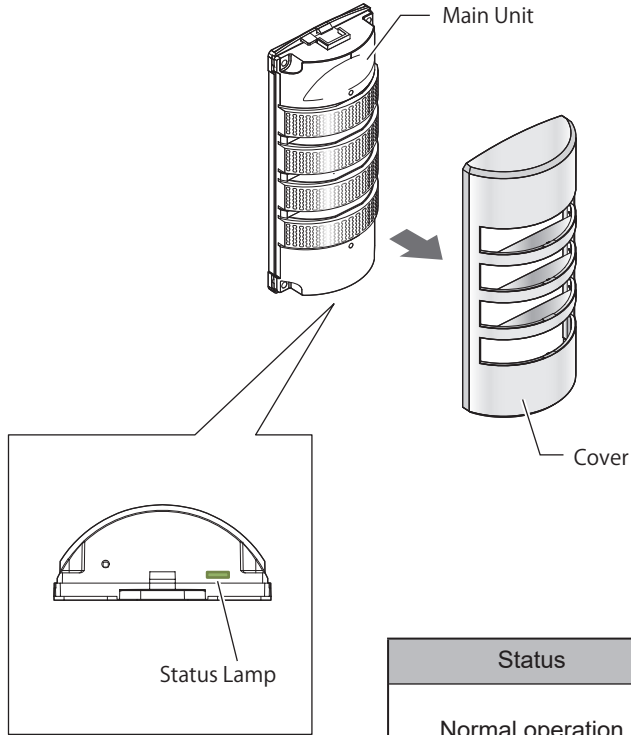

Status	Status Lamp	Description
Normal operation	Light on (Green) (momentarily flashes green during communication)	Power ON, operation

7. Before Use

This section describes the setup procedure required to use this product. Follow the steps below for setup.

STEP 1 Set Up Network Settings on the PC

STEP 2 Connect this product to a PC with a LAN cable

"6.3. Wiring Method" (👉 page 19)

STEP 3 Power up this product

"6.3. Wiring Method" (👉 page 19)

STEP 4 Set password

"7.2. Setting Up the Password" (👉 page 25)



Must be done at the time of purchase or after initializing the settings. After setup, the login screen will display.

STEP 5 Display the Web Setup Screen

"7.3. Displaying the Web Setup Screen" (👉 page 27)

STEP 6 Set up this product's Basic Settings

- Setting Up Product Network Settings
"7.4. Setting Up Product Network Settings" (👉 page 29)
- Select the lighting color and buzzer volume for each tier of Signal Tower
"7.5. Setting Up Main Unit" (👉 page 30)
- When controlled with PNS Commands
"7.6. Setting Up Command Reception Settings" (👉 page 31)
- When controlled with Modbus/TCP
"7.7. Setting up Modbus/TCP" (👉 page 32)



After completing the settings for your purpose, either cycle the power or reboot before starting operation of the product.

STEP 7 Use this product

"8. How to Use" (👉 page 36)

7.1. Setting Up Network Settings on the PC

- To display the product's Web Setup Screen, set up is required on a personal computer.
- The following setup procedure is based on the case of Windows 10 OS and this product is in the factory default state.
- When enabling the DHCP function on the Web Setup Screen, configure the settings to match your environment.

1 From the taskbar's "Windows Start menu", click "Settings" to enter the "Settings" screen.

2 Click "Network & Internet" to enter the "View network status and tasks" screen.

3 From "View network status and tasks", click "Change adapter options" to display the "Network Connections" screen.

4 Double-click either "Ethernet" or "Local Area Connection", used to connect the product.

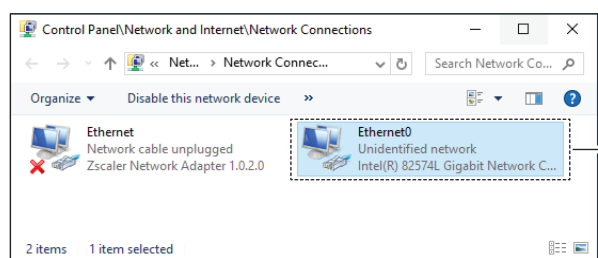
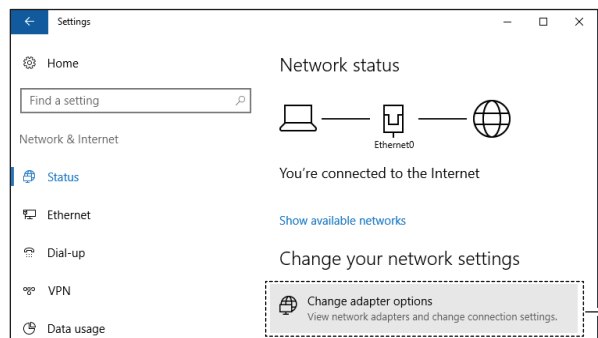
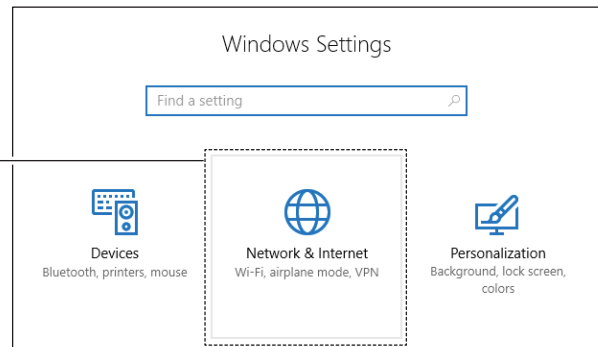

5 Click "Properties".

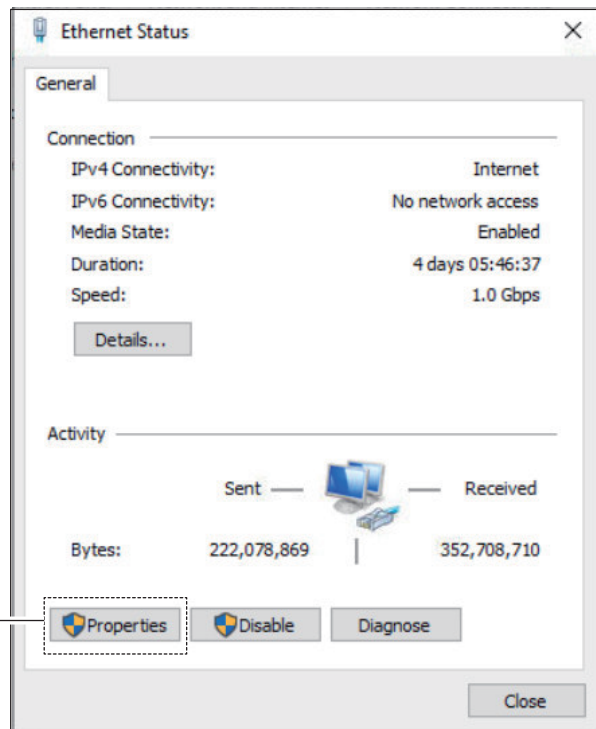

6 Select "Internet Protocol Version 4 (TCP/IPv4)" and click "Properties".

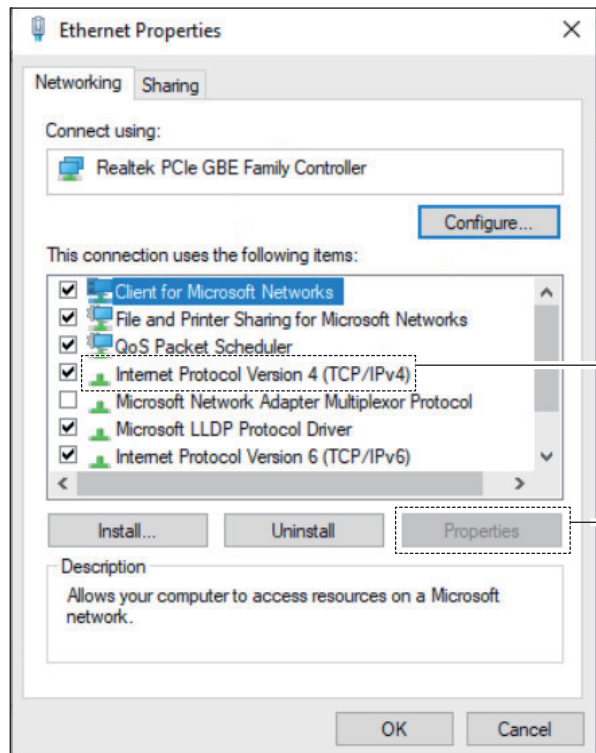

7 In the "General" tab, select the "Use the following IP address:" check box and set the items.

- IP address: 192.168.10.2 to 254
- Subnet mask: 255.255.255.0
- Default gateway: No setting is required for a direct connection. When connecting to a network, check with the network administrator.
- * Determine beforehand the settings you plan to use at run time.

8 After the entries are complete, click "OK".

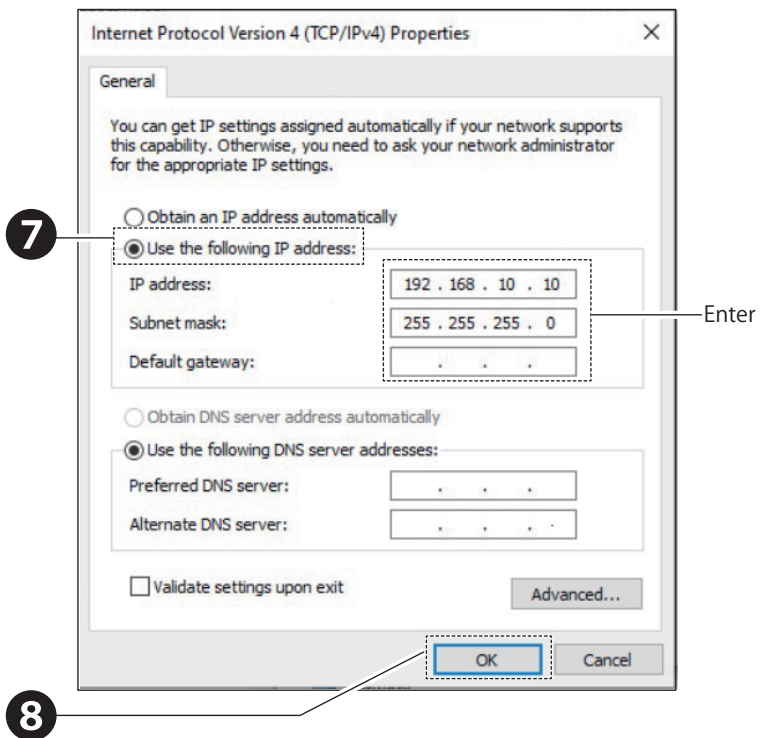

7.2. Setting Up the Password

- Web browsers supported by this product are "Google Chrome" and "Microsoft Edge".
- The instructions in this manual use "Google Chrome" as an example. Use "Microsoft Edge" in the same way.
- To specify various settings on this product, a password is required.
- When accessing the product with a browser for the first time after purchase or after initialization, the user authentication setting screen will be displayed instead of the login screen.



CAUTION

⚠ Do not forget the password. If you cannot remember password, you will not be able to log in.
If you cannot remember password, initialize the system and reset your password.

Point

- The first time access or after initialization, the display will be in English.
In the "Language Menu", select the display language.

1

Start a Web browser.

2

In the Web browser address bar, enter the IP address* set for this product.

- * The default IP address for this product is "192.168.10.1".
- * If the User authentication settings screen does not appear, confirm your computer's network settings are set up correctly.
"7.1. Setting Up Network Settings on the PC" (👉 page 22)

2

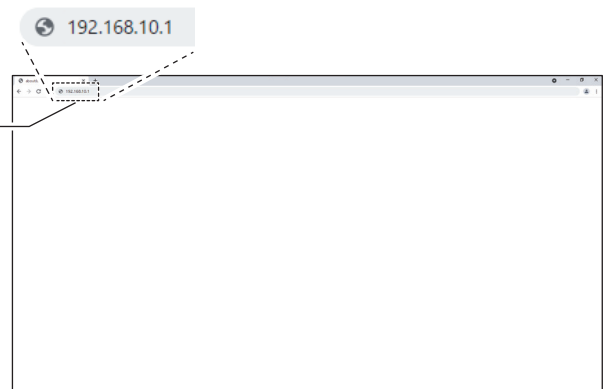

3

Select the language.

- 日本語 : Japanese
- 英語 : English

3

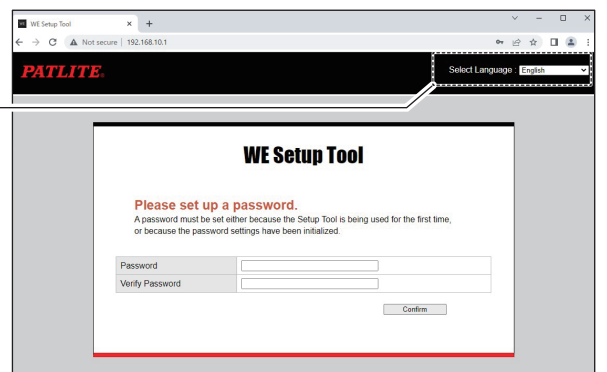

4 Enter the password and click the "Confirm" button.

- "Password": Enter the password
- "Verify Password": Enter the password again
- * The password must be 1 to 16 single-byte alphanumeric characters.
- * Password characters are case-sensitive.

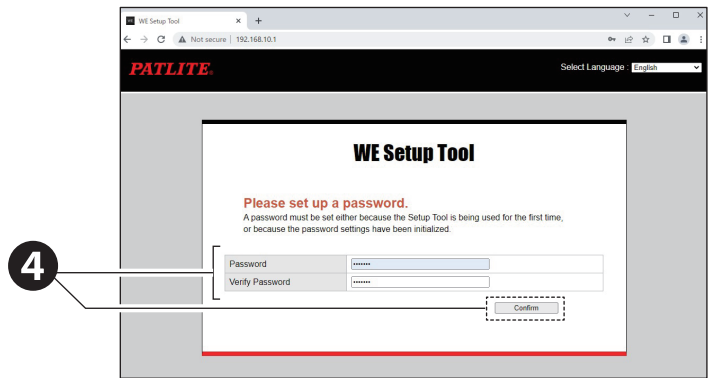

5 After completing the settings, click "To the Login screen" to return to the login screen.

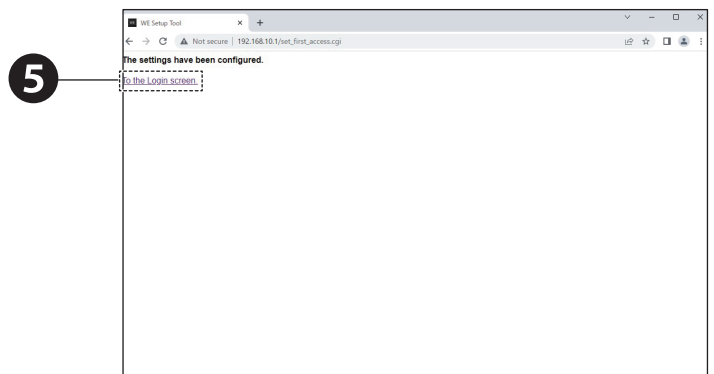

7.3. Displaying the Web Setup Screen



CAUTION

- ⚠ While logged in, after a specified period of inactivity (approx. 10 minutes) you are automatically logged out.
- ⚠ If the screen does not display correctly due to corrupted characters, change the character encoding to Unicode (UTF-8).
- ⚠ To prevent set up from multiple locations at the same time, duplicate logins are not allowed.

1

Start a Web browser.

2

In the Web browser address bar, enter the IP address* set for this product.

- * The default IP address for this product is "192.168.10.1".
- * If the User authentication settings screen does not appear, confirm your computer's network settings are set up correctly.
"7.1. Setting Up Network Settings on the PC" (👉 page 22)

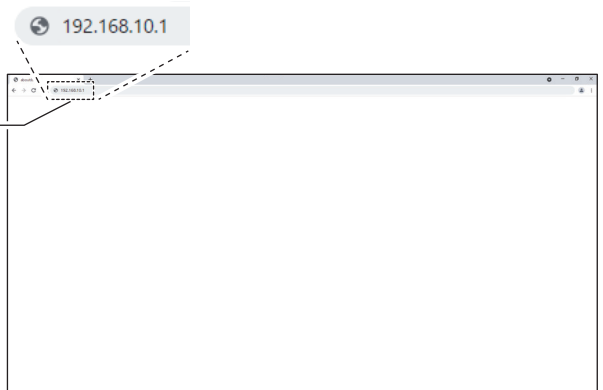

3

Select the language.

- ・ 日本語 : Japanese
- ・ 英語 : English

4

Enter the Password*.

- * If you forget your password, please reset it.
"9.1. Initialization Method" (👉 page 66)

5

Click the "Login" button to log in.

- ・ On a successful log in, the Web Setup Screen (home screen) is displayed.

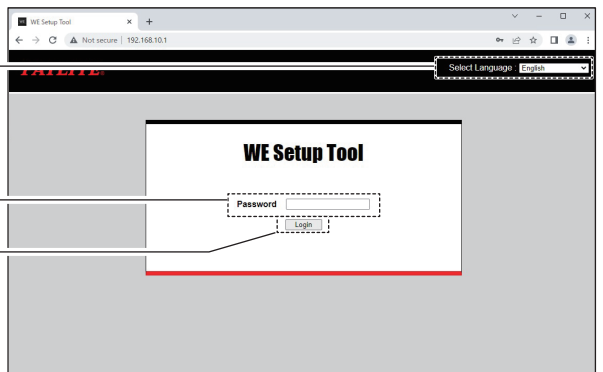

● How to Read the Top Screen

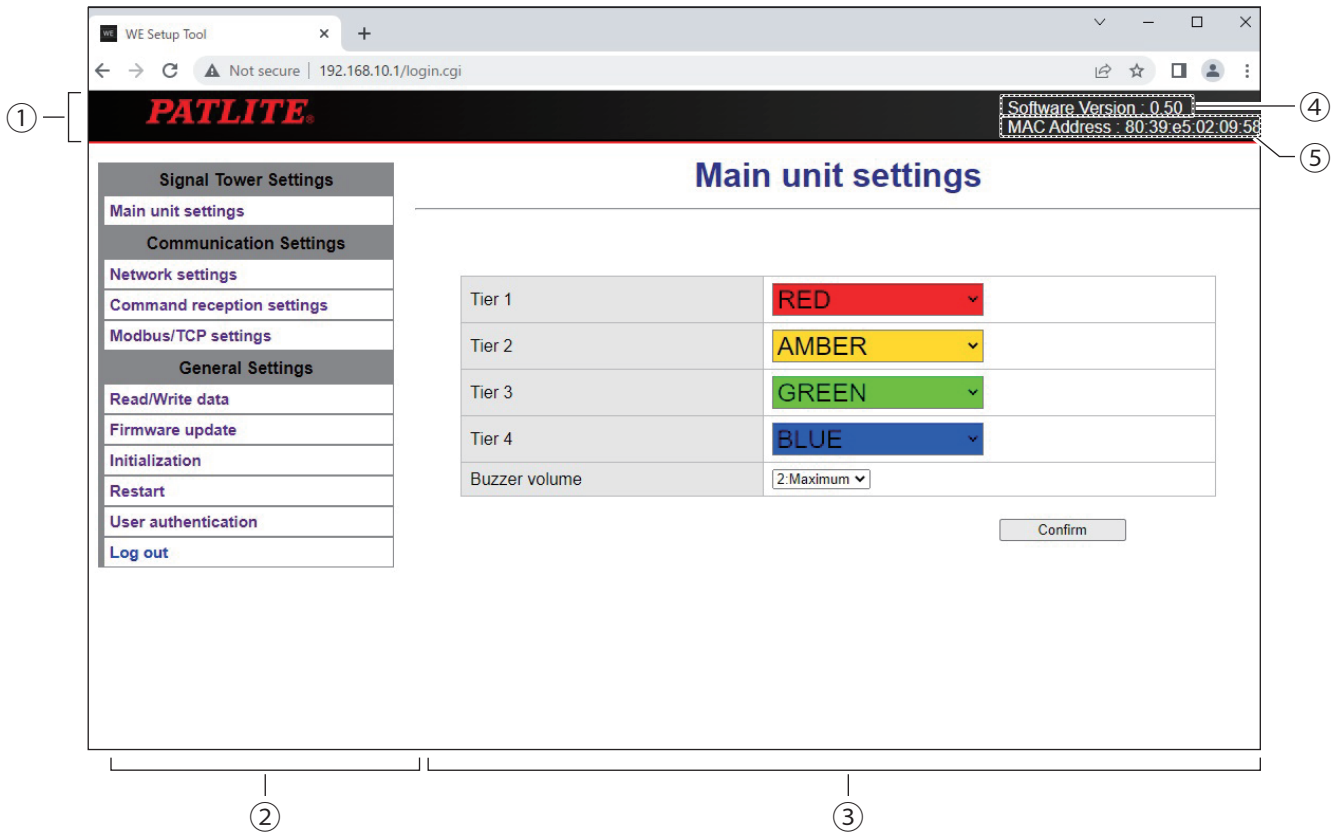

No.	Name	Description
①	Header	Displays the product information.
②	Menu	Navigate to each function.
③	Setting Screen	Set the of each function.
④	Software version	Check the firmware version that this product is currently using.
⑤	MAC Address	Check the MAC Address of this product.



Point

- To configure a setting, from the menu on the left-hand side click the item you want to set. The selected set up screen is displayed.
- After entering settings on each setup screen, click the "Confirm" button to apply.
 - "Setup complete" is displayed: The settings are applied.
 - "Error" is displayed: There are errors in the settings. Set up as required again.

7.4. Setting Up Product Network Settings

- To use this product, the network settings must be configured.
- The default IP address is 192.168.10.1.

CAUTION

-  When IP address configuration is set to "Automatic Settings", and access to the DHCP server is unavailable, the product starts up with the factory default network settings.
-  With the "Automatic Settings" option, the product restarts with the DHCP function enabled.
-  After changing the IP address, to reconnect to the product change the network settings on your computer as required.

- From the "Main unit settings" tab, click "Network settings" to enter the "Network settings" screen.
- Select the "Setting method".
 - To specify a fixed IP address, select "Set manually".
 - To obtain an IP address automatically from the DHCP server, select "Obtain automatically".
- Enter the "IP address", "Subnet Mask", and "Default gateway".
 - Enter the settings in accordance with the network environment in which this product is used.
 - * If the "Setting Method" is "Obtain automatically", input is disabled.
- Enter the product's host name.
- Click "Confirm" to apply the defined settings.

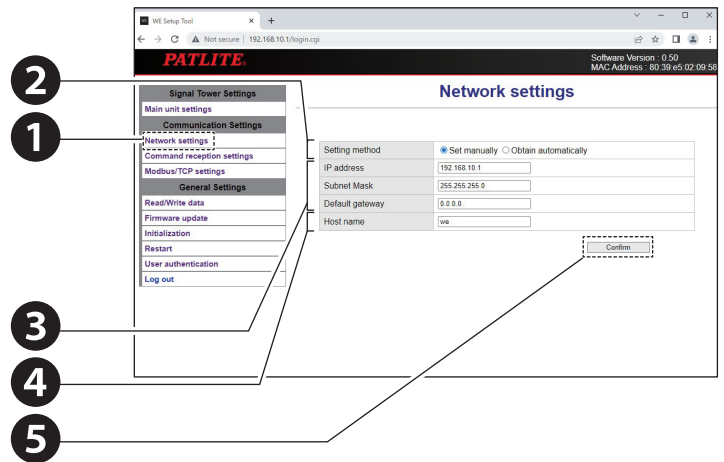

* After the settings are applied, the product is automatically restarted.

Item	Description	Default Value	Input Range	Input
Setting Method	Select how to configure the IP address for this product.	Set manually	—	Required
IP address	Enter the IP address of this product.	192.168.10.1	IP address format	Required
Subnet Mask	Enter the subnet mask of this product.	255.255.255.0	IP address format	Required
Default Gateway	Enter the default gateway.	0.0.0.0	IP address format	Required
Host name	Enter the product's host name.	we	Maximum 63 characters*	Required

* You can register up to 63 characters, including alphanumeric characters, "-" (hyphen)" and "." (period)".

Point

- When "Obtain automatically" is selected, the host name is notified to the DHCP server.

7.5. Setting Up Main Unit

- You can select the lighting color and buzzer volume for each tier of Signal Tower with the "Main unit settings" screen.
- There are two ways to set up this product: "Write setup data" and "Web setup".

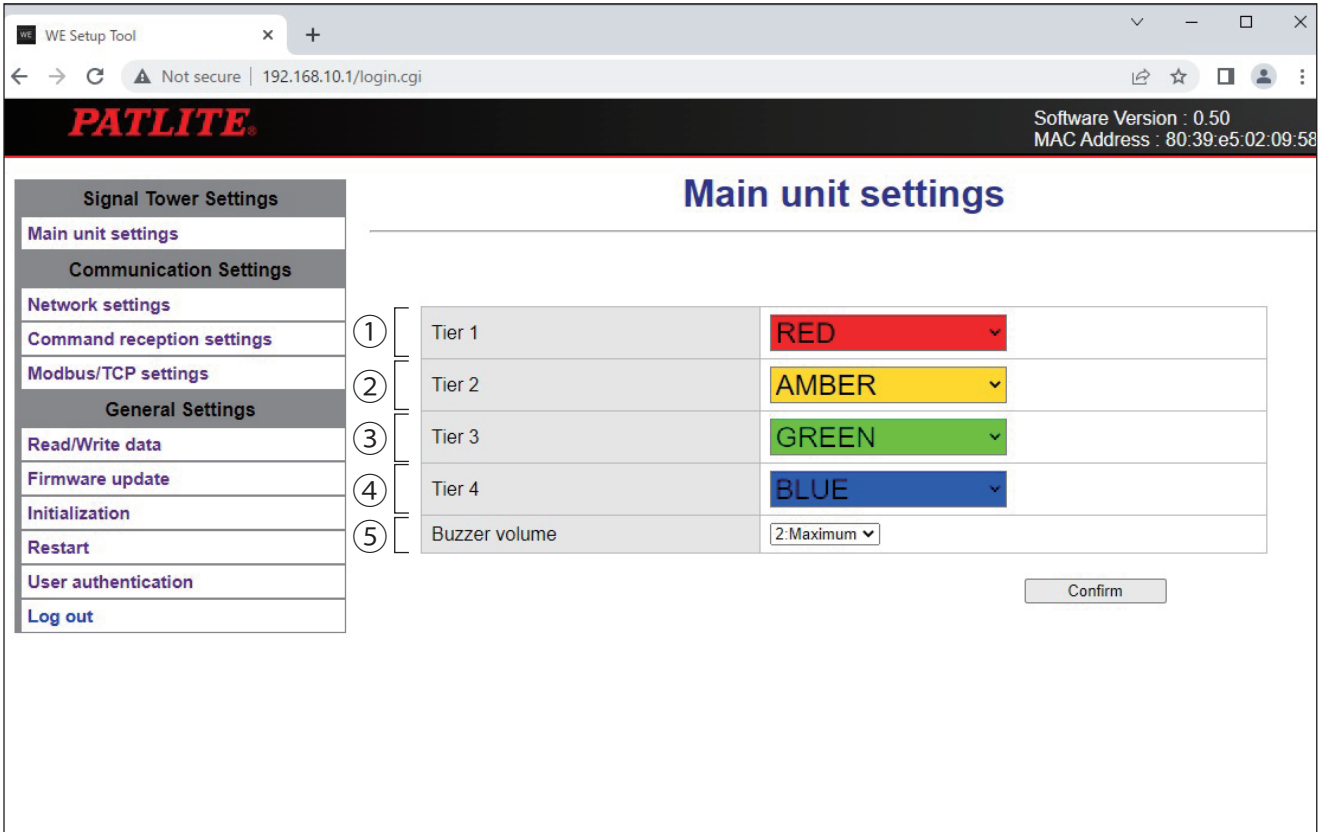

No.	Item	Description	Default Value
①	Tier 1	Select from BLACK (light off) ^{*1} / RED / AMBER / LEMON / GREEN / CYAN / BLUE / PURPLE / PINK / WHITE.	RED
②	Tier 2		AMBER
③	Tier 3		GREEN
④	Tier 4		BLUE
⑤	Buzzer volume	Select from 0 (mute) ^{*2} / 1 (reduce volume) / 2 (Maximum).	2: Maximum

*1 The Signal Tower tiers with BLACK selected do not light up.

*2 When the buzzer volume is set to 0 (mute), the buzzer will not emit.

7.6. Setting Up Command Reception Settings

Setting for receiving "PNS commands".

- 1** From the Menu, click "Command reception settings" to enter the "Command reception settings" screen.
- 2** Enter the port number for receiving data.
- 3** Select protocol from "TDP / UDP".
 - TCP: Transmission Control Protocol
 - UDP: User Datagram Protocol
- 4** Click "Confirm" to apply the defined settings.

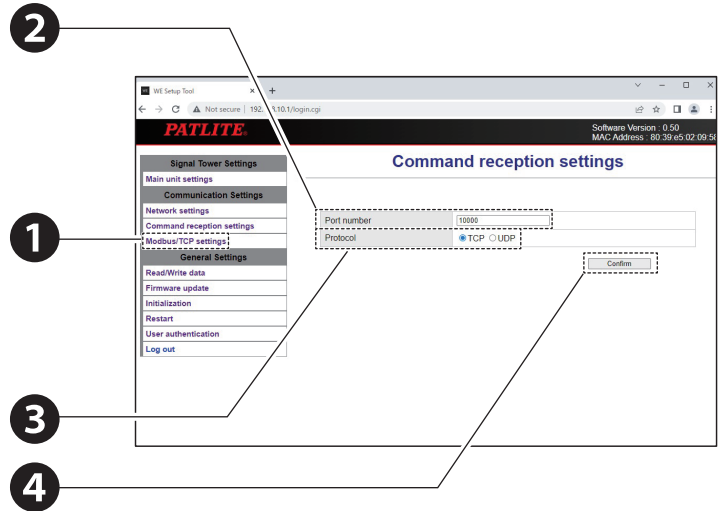

Item	Description	Default Value	Input Range	Input
Port number	Enter the port number for receiving data.	10000	10000 to 65535*	Required
Protocol	Select either "TCP" or "UDP".	TCP	—	Required

* You cannot set the same port number as the Modbus/TCP.

7.7. Setting up Modbus/TCP

Setting up the port number for Modbus/TCP.

- 1** From the Menu, click "Modbus/TCP settings" to enter the "Modbus/TCP settings" screen.
- 2** Enter the port number to use.
- 3** Click "Confirm" to apply the defined settings.

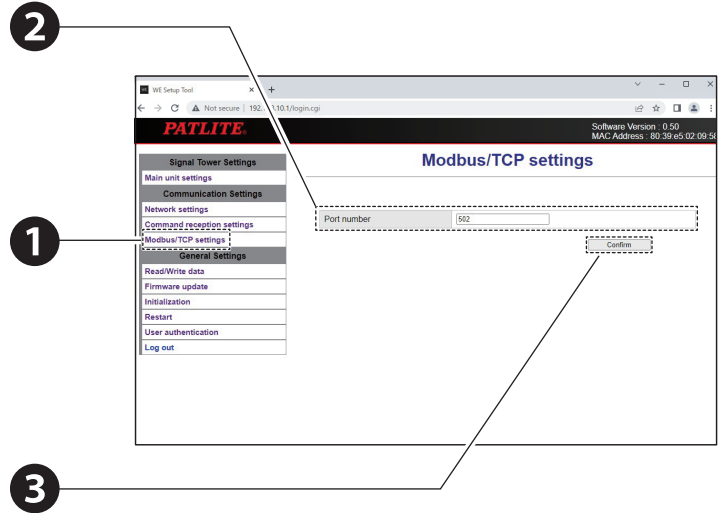

Item	Description	Default Value	Input Range	Input
Port number	Enter the port number to use.	502	502, or 1024 to 65535 [*]	Required

* You cannot set the same port number as the PNS command.

7.8. Reading the Setup Data

- You can read setting items of this product and saved as setup data on a PC.
- You can select and write the setup data of this product that has been read.

1 From the Menu, click "Read/Write data" to enter the "Read/Write data" screen.

2 Click the "Read" button.

3 Save the setup data on a PC.

- Note:
- While reading the setup data and you transmit a command, the associated operation will not run.
 - The setup data consists of operation settings registered in the main unit.
 - The following content is not included in the setup data.
 - Network Settings
 - User Authentication Settings

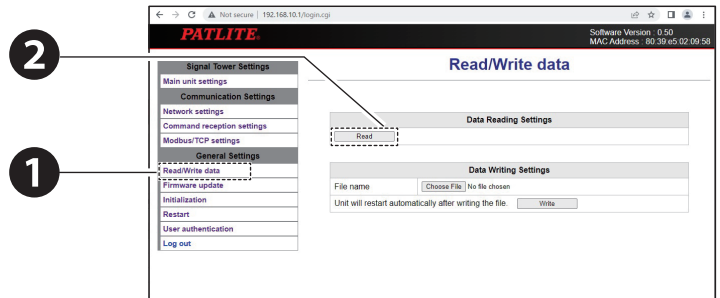

7.9. Writing the Setup Data

You can write set up data saved in "7.8. Reading the Setup Data".

1 From the Menu, click "Read/Write data" to enter the "Read/Write data" screen.

2 Click the "Choose File" button.

3 Select the configuration data to write and click the "Open" button.

4 Click the "Write" button to update the settings.

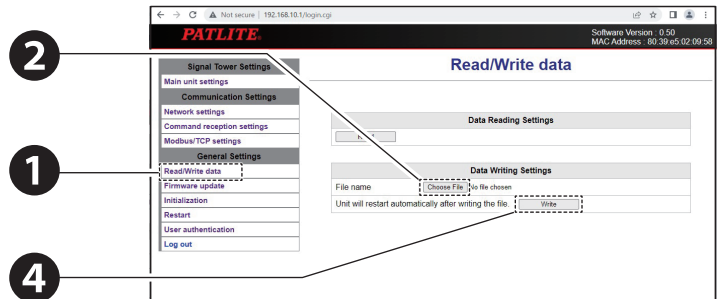

The unit automatically reboots after setup.

Note: Do not register any setting data other than this product's setup data. Failure to follow these instructions will result in equipment failure.

7.10. How to logout from the Web setup screen

After completing the settings on the Web setup screen, click the "Log out" button to log out.

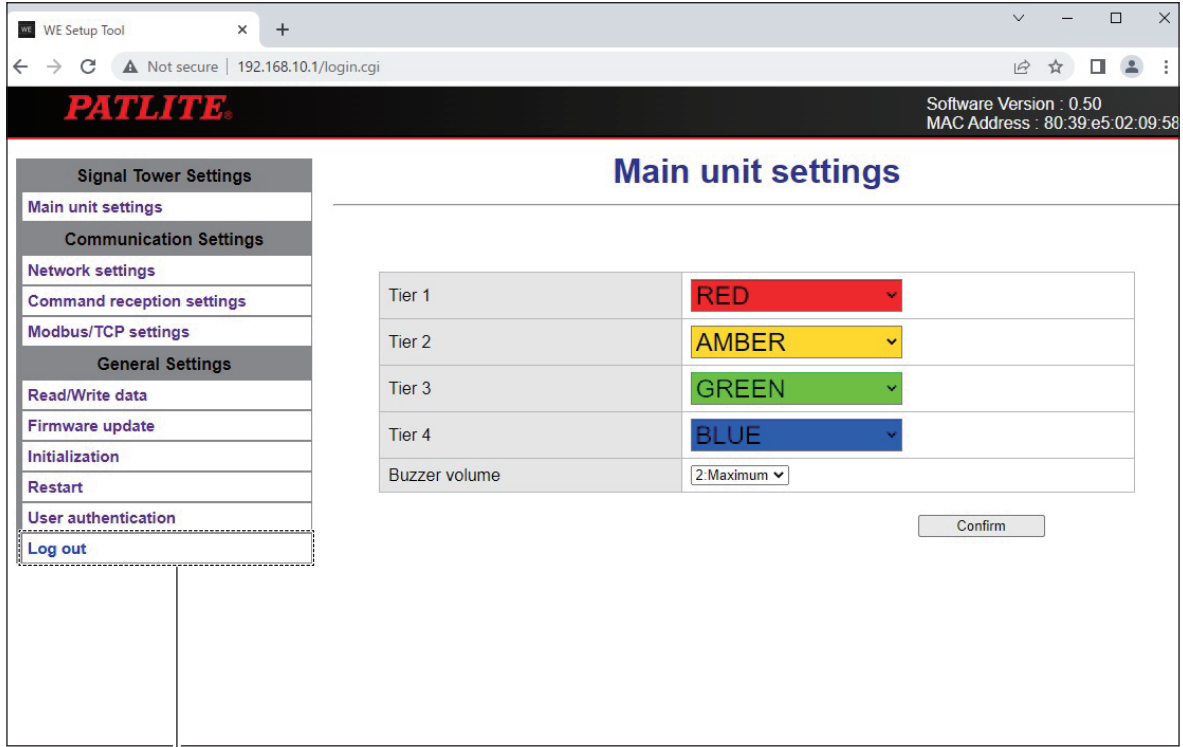

Click when settings are complete.

8. How to Use

8.1. PNS Commands

- By sending PNS commands from your computer, you can do things like control this product or get its status.
- For the protocol, select either "TCP" or "UDP".
- You can use communication port numbers 10000 to 65535.

● Communication Protocols

Protocol	Port Number
TCP	10000 to 65535
UDP	

Point

- Set up PNS command settings in the "Command Configuration" screen. "7.6. Setting Up Command Reception Settings" (👉 page 31)
- Using PNS command, you can create up to 8 simultaneous connections.

● Commands You Can Execute

ID	Command	Overview
S (53H)	Signal Tower motion control	<ul style="list-style-type: none"> • Controls tier 1 to 4 of the Signal Tower by command with colors set on the Web screen. • Controls the buzzer with commands
D (44H)	Detailed motion control (flashing all tiers)	<ul style="list-style-type: none"> • Controls all tiers by specifying color for the tier 1 to 4 of the Signal Tower with commands. • Controls the buzzer with commands
F (46H)	Detailed motion control (flashing individual)	<ul style="list-style-type: none"> • Individually controls tier 1 to 4 of the Signal Tower by specifying color for each tier with commands. • Controls the buzzer with commands
C (43H)	Clear	Turns off the Signal Tower and stops the buzzer.
G (47H)	Get Status	Gets the status of this product.
E (45H)	Get Status Details	Gets details about the status of this product, including color information.
V (56H)	Buzzer volume setting	Set up the volume of the buzzer.

8.1.1. Signal Tower Motion Control Commands

- You can control tier 1 to 4 and buzzers with the Signal Tower pattern specified in the data area.
- This product operates with the color and buzzer volume set on the Web screen.

Request Command

- Transmission Data Format

Product Category ^{*1}		ID ^{*2}	Unused	Data Size		Data Area ^{*3} (6 bytes)					
A	B	S	–	–	–	1	2	3	4	5	6
41H	42H	53H	00H	00H	06H	Signal Tower pattern (Tier 1)	Signal Tower pattern (Tier 2)	Signal Tower pattern (Tier 3)	Signal Tower pattern (Tier 4)	(unused)	Buzzer pattern
1 byte	1 byte	1 byte	1 byte	2 bytes		1 byte	1 byte	1 byte	1 byte	1 byte	1 byte

* 1 This product's product category is "AB".

* 2 Use "S" for ID.

* 3 Data area is as follows.

Type	Value	Description
Signal Tower pattern	00H	Light off
	01H	Light on
	02H	Flashing (slow)
	03H	Flashing (medium)
	04H	Flashing (fast)
	05H	Single flash
	06H	Double flash
	07H	Triple flash
	08H	Pulse (bright and dark)
	09H	No change
	0AH	Right chase light
	0BH	Left chase light

Type	Value	Description
Buzzer pattern	00H	Stop
	01H	Buzzer pattern 1
	02H	Buzzer pattern 2
	03H	Buzzer pattern 3
	04H	Buzzer pattern 4
	05H	Buzzer pattern 5
	06H	Buzzer pattern 6
	07H	Buzzer pattern 7
	08H	Disabled, ACK response
	09H	No change

Response Command

Normal response
ACK
06H
1 byte

Error response
NAK
15H
1 byte

Example Transmission

- Signal Tower: "Tier 1: Light on", "Tier 2 and 3: Flashing (slow)", "Tier 4: Light off"
- Buzzer: Pattern 1

Product Category AB		ID S	Unused	Data Size		Data Area (6 bytes)					
						1	2	3	4	5	6
41H	42H	53H	00H	00H	06H	01H	02H	02H	00H	00H	01H

8.1.2 Detailed Motion Control (All-tiers Flashing) Command

- You can specify and control the color and pattern of each tier of the Signal Tower and the buzzer pattern in the data area.
- Operates buzzer volume set up in Web Screen.

Request Command

- Transmission Data Format

Product Category ¹		ID ²	Unused	Data Size		Data Area ³ (7 bytes)						
A	B	D				1	2	3	4	5	6	7
41H	42H	44H	00H	00H	07H	Signal Tower color (Tier 1)	Signal Tower color (Tier 2)	Signal Tower color (Tier 3)	Signal Tower color (Tier 4)	(unused) 00H	Signal Tower pattern	Buzzer pattern
1 byte	1 byte	1 byte	1 byte	2 bytes		1 byte	1 byte	1 byte	1 byte	1 byte	1 byte	1 byte

* 1 This product's product category is "AB".

* 2 Use "D" for ID.

* 3 Data area is as follows.

Type	Value	Description
Signal Tower color	00H	Light off
	01H	Red
	02H	Amber
	03H	Lemon
	04H	Green
	05H	Cyan
	06H	Blue
	07H	Purple
	08H	Pink
	09H	White

Type	Value	Description
Signal Tower pattern	00H	No flashing
	01H	Flashing (slow)
	02H	Flashing (medium)
	03H	Flashing (fast)
	04H	Single flash
	05H	Double flash
	06H	Triple flash
	07H	Pulse (bright and dark)
	08H	Right chase light
09H	Left chase light	

Type	Value	Description
Buzzer pattern	00H	Stop
	01H	Buzzer pattern 1
	02H	Buzzer pattern 2
	03H	Buzzer pattern 3
	04H	Buzzer pattern 4
	05H	Buzzer pattern 5
	06H	Buzzer pattern 6
	07H	Buzzer pattern 7
	08H	Disabled, ACK response
09H	No change	

Response Command

Normal response	Error response
ACK	NAK
06H	15H
1 byte	1 byte

Example Transmission

- Signal Tower: "Tier 1: Red", "Tier 2: Lemon", "Tier 3: Green", "Tier 4: Blue, Flashing (fast)"
- Buzzer: Pattern 2

Product Category AB		ID D	Unused	Data Size		Data Area (7 bytes)						
1	2	3	4	5	6	7	8	9	10	11	12	
41H	42H	44H	00H	00H	07H	01H	03H	04H	06H	00H	03H	02H

Point

- Setting on Web screen for the color of Signal Tower is no longer valid.
- Detailed motion control (flashing all tiers) command make all tiers of the Signal Tower to flash, in accordance with the pattern.

8.1.3 Detailed Motion Control (Flashing Individual) Commands

- You can control the color, pattern and buzzer pattern for tier 1 to 4 of the Signal Tower with the values specified in the data area.
- Operates buzzer volume set up in Web Screen.

Request Command

- Transmission Data Format

Product Category ¹		ID ²	Unused	Data Size	
A	B	F	-	-	-
41H	42H	46H	00H	00H	0BH
1 byte	1 byte	1 byte	1 byte	2 bytes	

Data Area ³ (11 bytes)										
1	2	3	4	5	6	7	8	9	10	11
Signal Tower color tier 1	Signal Tower color tier 2	Signal Tower color tier 3	Signal Tower color tier 4	(unused)	Buzzer pattern	Signal Tower pattern tier 1	Signal Tower pattern tier 2	Signal Tower pattern tier 3	Signal Tower pattern tier 4	(unused)
				00H						00H
1 byte	1 byte	1 byte	1 byte	1 byte	1 byte	1 byte	1 byte	1 byte	1 byte	1 byte

* 1 This product's product category is "AB".

* 2 Use "F" for ID.

* 3 Data area is as follows.

Type	Value	Description
Signal Tower color	00H	Light off
	01H	Red
	02H	Amber
	03H	Lemon
	04H	Green
	05H	Cyan
	06H	Blue
	07H	Purple
	08H	Pink
	09H	White

Type	Value	Description
Signal Tower pattern	00H	No flashing
	01H	Flashing (slow)
	02H	Flashing (medium)
	03H	Flashing (fast)
	04H	Single flash
	05H	Double flash
	06H	Triple flash
	07H	Pulse (bright and dark)
	08H	Right chase light
	09H	Left chase light

Type	Value	Description
Buzzer pattern	00H	Stop
	01H	Buzzer pattern 1
	02H	Buzzer pattern 2
	03H	Buzzer pattern 3
	04H	Buzzer pattern 4
	05H	Buzzer pattern 5
	06H	Buzzer pattern 6
	07H	Buzzer pattern 7
	08H	Disabled, ACK response
	09H	No change

Response Command

Normal response	Error response
ACK	NAK
06H	15H
1 byte	1 byte

Example Transmission

- Signal Tower: "Tier 1: Red, No flashing", "Tier 2: Amber, flashing (medium)", "Tier 3: Blue, No flashing", "Tier 4: White, Pulse (bright and dark)"
- Buzzer: Pattern 7

Product Category AB		ID F	Unused	Data Size	
41H	42H	46H	00H	00H	0BH

Data Area (11 bytes)										
1	2	3	4	5	6	7	8	9	10	11
01H	02H	06H	09H	00H	07H	00H	02H	00H	07H	00H

Point

- Setting on Web screen for the color of Signal Tower is no longer valid.

8.1.4. Clear Command

Turns off the Signal Tower and stops the buzzer.

Request Command

• Transmission Data Format

Product Category ^{*1}		ID ^{*2}	Unused	Data Size	
A	B	C	–	–	–
41H	42H	43H	00H	00H	00H
1 byte	1 byte	1 byte	1 byte	2 bytes	

* 1 This product's product category is "AB".

* 2 Use "C" for ID.

Response Command

Normal response	Error response
ACK	NAK
06H	15H
1 byte	1 byte

8.1.5. Get Status Command

You can get the Signal Tower pattern and buzzer status for each tier of the Signal Tower.

Request Command

• Transmission Data Format

Product Category ^{*1}		ID ^{*2}	Unused	Data Size	
A	B	G	–	–	–
41H	42H	47H	00H	00H	00H
1 byte	1 byte	1 byte	1 byte	2 bytes	

* 1 This product's product category is "AB".

* 2 Use "G" for ID.

Response Command

• Response Data (Normal response)

Data Area (15 bytes)														
1	2	3	4	5	6	7	8	9	10	11	12	13	14	15
(unused)	(unused)	(unused)	(unused)	(unused)	(unused)	(unused)	(unused)	(unused)	Signal Tower pattern tier 1	Signal Tower pattern tier 2	Signal Tower pattern tier 3	Signal Tower pattern tier 4	(unused)	Buzzer pattern
00H	00H	00H	00H	00H	00H	00H	00H	00H					00H	
1 byte	1 byte	1 byte	1 byte	1 byte	1 byte	1 byte	1 byte	1 byte	1 byte	1 byte	1 byte	1 byte	1 byte	1 byte

• Data Area

Type	Value	Description
Signal Tower pattern	00H	Light off
	01H	Light on
	02H	Flashing (slow)
	03H	Flashing (medium)
	04H	Flashing (fast)
	05H	Single flash
	06H	Double flash
	07H	Triple flash
	08H	Pulse (bright and dark)
	0AH	Right chase light
	0BH	Left chase light

Type	Value	Description
Buzzer pattern	00H	Stop
	01H	Buzzer pattern 1
	02H	Buzzer pattern 2
	03H	Buzzer pattern 3
	04H	Buzzer pattern 4
	05H	Buzzer pattern 5
	06H	Buzzer pattern 6
	07H	Buzzer pattern 7

• Response Data (Error response)

Error response
NAK
15H
1 byte

Example Response

- Signal Tower: "Tier 1: Light on", "Tier 2: Flashing (medium)", "Tier 3: light on", "Tier 4: Pulse (bright and dark)"
- Buzzer: Pattern 7

Data Area (15 bytes)														
1	2	3	4	5	6	7	8	9	10	11	12	13	14	15
(unused)	(unused)	(unused)	(unused)	(unused)	(unused)	(unused)	(unused)	(unused)	Signal Tower pattern tier 1	Signal Tower pattern tier 2	Signal Tower pattern tier 3	Signal Tower pattern tier 4	(unused)	Buzzer pattern
00H	00H	00H	00H	00H	00H	00H	00H	00H	01H	03H	01H	08H	00H	07H

8.1.6. Get Status Details Command

You can get the MAC address of the product, the Signal Tower pattern and color for each tier of the Signal Tower, and buzzer status.

Request Command

- Transmission Data Format

Product Category ^{*1}		ID ^{*2}	Unused	Data Size	
A	B	E	-	-	-
41H	42H	45H	00H	00H	00H
1 byte	1 byte	1 byte	1 byte	2 bytes	

* 1 This product's product category is "AB".

* 2 Use "E" for ID.

Response Command

- Response Data (Normal response)

Data Area (40 bytes)													
1	2	3	4	5	6	7	8	9	10	11	12	13	14
MAC Address						(unused)	(unused)	(unused)	(unused)	(unused)	(unused)	(unused)	(unused)
						00H	00H	00H	00H	00H	00H	00H	00H
1 byte	1 byte	1 byte	1 byte	1 byte	1 byte	1 byte	1 byte	1 byte	1 byte	1 byte	1 byte	1 byte	1 byte

Data Area (40 bytes)													
15	16	17	18	19	20	21	22	23	24	25	26	27	
(unused)	(unused)	(unused)	(unused)	(unused)	Signal Tower tier 1				Signal Tower tier 2				
00H	00H	00H	00H	00H	Pattern	Color (R)	Color (G)	Color (B)	Pattern	Color (R)	Color (G)	Color (B)	
1 byte	1 byte	1 byte	1 byte	1 byte	1 byte	1 byte	1 byte	1 byte	1 byte	1 byte	1 byte	1 byte	

Data Area (40 bytes)													
28	29	30	31	32	33	34	35	36	37	38	39	40	
Signal Tower tier 3				Signal Tower tier 4				(unused)	(unused)	(unused)	(unused)	Buzzer pattern	
Pattern	Color (R)	Color (G)	Color (B)	Pattern	Color (R)	Color (G)	Color (B)	00H	00H	00H	00H		
1 byte	1 byte	1 byte	1 byte	1 byte	1 byte	1 byte	1 byte	1 byte	1 byte	1 byte	1 byte	1 byte	

• Data Area

Type	Value	Description
Signal Tower pattern	00H	Light off
	01H	Light on
	02H	Flashing (slow)
	03H	Flashing (medium)
	04H	Flashing (fast)
	05H	Single flash
	06H	Double flash
	07H	Triple flash
	08H	Pulse (bright and dark)
	0AH	Right chase light
	0BH	Left chase light

Type	Value			Description
	Color (R)	Color (G)	Color (B)	
Signal Tower color	FFH	00H	00H	Red
	FFH	CCH	00H	Amber
	EEH	FFH	00H	Lemon
	00H	FFH	00H	Green
	00H	BBH	DDH	Cyan
	00H	33H	FFH	Blue
	CCH	00H	DDH	Purple
	FFH	00H	CCH	Pink
	FFH	FFH	FFH	White

Type	Value	Description
Buzzer pattern	00H	Stop
	01H	Buzzer pattern 1
	02H	Buzzer pattern 2
	03H	Buzzer pattern 3
	04H	Buzzer pattern 4
	05H	Buzzer pattern 5
	06H	Buzzer pattern 6
	07H	Buzzer pattern 7

• Response Data (Error response)

Error response
NAK
15H
1 byte

Example Response

- MAC address of this product: "80:39:E5:00:1A:2F"
- Signal Tower: "Tier 1: Red, Light on", "Tier 2: Amber, Flashing (medium)", "Tier 3: Blue, Light on", "Tier 4: White, Pulse (bright and dark)"
- Buzzer: Pattern 7

Data Area (40 bytes)													
1	2	3	4	5	6	7	8	9	10	11	12	13	14
MAC Address						(unused)	(unused)	(unused)	(unused)	(unused)	(unused)	(unused)	(unused)
80H	39H	E5H	00H	1AH	2FH	00H	00H	00H	00H	00H	00H	00H	00H

Data Area (40 bytes)													
15	16	17	18	19	20	21	22	23	24	25	26	27	
(unused)	(unused)	(unused)	(unused)	(unused)	Signal Tower tier 1				Signal Tower tier 2				
					Pattern	Color (R)	Color (G)	Color (B)	Pattern	Color (R)	Color (G)	Color (B)	
00H	00H	00H	00H	00H	01H	FFH	00H	00H	03H	FFH	CCH	00H	

Data Area (40 bytes)													
28	29	30	31	32	33	34	35	36	37	38	39	40	
Signal Tower tier 3				Signal Tower tier 4				(unused)	(unused)	(unused)	(unused)	Buzzer pattern	
Pattern	Color (R)	Color (G)	Color (B)	Pattern	Color (R)	Color (G)	Color (B)						
01H	00H	33H	FFH	08H	FFH	FFH	FFH	00H	00H	00H	00H	07H	

8.1.7. Buzzer Volume Setting Command

Set up the volume to play the buzzer.

Request Command

• Transmission Data Format

Product Category ^{*1}		ID ^{*2}	Unused	Data Size		Data Area ^{*3}
A	B	V	–	–	–	Buzzer volume
41H	42H	56H	00H	00H	01H	
1 byte	1 byte	1 byte	1 byte	2 bytes		1 byte

* 1 This product's product category is "AB".

* 2 Use "V" for ID.

* 3 Data area is as follows.

Type	Value	Description
Buzzer volume	00H	Mute
	01H	Reduce Volume
	02H	Maximum

Response Command

Normal response	Error response
ACK	NAK
06H	15H
1 byte	1 byte

8.2. Modbus/TCP

- By sending commands from a Modbus/TCP supported master device, you can do things like control this product or get its status.
- You can use communication port numbers 502, and 1024 to 65535.

Point

- Set up Modbus/TCP settings in the Modbus/TCP Setup. For information, refer to "7.7. Setting up Modbus/TCP" (page 32).
- Using Modbus/TCP, the total number of units that can be connected simultaneously is 8.

Modbus/TCP Data Structure

Transaction ID	Protocol ID	Field Length	Unit ID	Function Code	Data
2 bytes	2 bytes	2 bytes	1 byte	1 byte	n bytes

Area Name	Description
Transaction ID	0000H to FFFFH
Protocol ID	0000H Fixed
Field Length	Number of bytes following Unit ID
Unit ID	00H to FFH
Function Code	Code that identifies the function defined in Modbus
Data	Data string defined for each function code

8.2.1. Function Code

The following function codes are supported by this product.

Code (Hex)	Function Name	Description
03H	Read Holding Registers	Gets the current state of the Signal Tower and buzzer.
06H	Write Single Register	Changes 1 data in the Data Address Register, and controls the Signal Tower and buzzer.
08H	Diagnostics	Gets the power status of this product.
10H	Write Multiple Registers	Changes multiple data in the Data Address Register, and controls the Signal Tower and buzzer.

8.2.2. Register Address

Register Address	Control	Data	
1 (01H)	Signal Tower motion control Signal Tower Tier 1	High	00H: Do not control, 01H: Control
		Low	Signal Tower motion control. Refer to Signal Tower pattern (low) ^{*1}
2 (02H)	Signal Tower motion control Signal Tower Tier 2	High	00H: Do not control, 01H: Control
		Low	Signal Tower motion control. Refer to Signal Tower pattern (low) ^{*1}
3 (03H)	Signal Tower motion control Signal Tower Tier 3	High	00H: Do not control, 01H: Control
		Low	Signal Tower motion control. Refer to Signal Tower pattern (low) ^{*1}
4 (04H)	Signal Tower motion control Signal Tower Tier 4	High	00H: Do not control, 01H: Control
		Low	Signal Tower motion control. Refer to Signal Tower pattern (low) ^{*1}
5 (05H)	Not used		Not used
6 (06H)	Signal Tower motion control buzzer	High	00H: Do not control, 01H: Control
		Low	Signal Tower Motion control. Refer to buzzer pattern (low)
7 (07H)	Not used		Not used
8 (08H)	Clear	High	00H (static)
		Low	00H: No change (when reading), 01H: Execute Clear: ^{*2}
9 (09H)	Not used		Not used
10 (0AH)	Not used		Not used
11 (0BH)	Not used		Not used
12 (0CH)	Detailed motion control Signal Tower Tier 1 Color	High	00H: Do not control, 01H: Control
		Low	Detailed motion control. Refer to Signal Tower Color (low) ^{*3}
13 (0DH)	Detailed motion control Signal Tower Tier 2 Color	High	00H: Do not control, 01H: Control
		Low	Detailed motion control. Refer to Signal Tower Color (low) ^{*3}
14 (0EH)	Detailed motion control Signal Tower Tier 3 Color	High	00H: Do not control, 01H: Control
		Low	Detailed motion control. Refer to Signal Tower Color (low) ^{*3}
15 (0FH)	Detailed motion control Signal Tower Tier 4 Color	High	00H: Do not control, 01H: Control
		Low	Detailed motion control. Refer to Signal Tower Color (low) ^{*3}
16 (10H)	Not used		Not used
17 (11H)	Detailed motion control Signal Tower pattern (all tiers)	High	00H: Do not control, 01H: Control
		Low	Detailed motion control. Refer to Signal Tower pattern (low) ^{*4}
18 (12H)	Detailed motion control Buzzer pattern	High	00H: Do not control, 01H: Control
		Low	Detailed motion control. Refer to Buzzer pattern (low) ^{*5}
19 (13H)	Detailed motion control Signal Tower pattern (Tier 1)	High	00H: Do not control, 01H: Control
		Low	Detailed motion control. Refer to Signal Tower pattern (low) ^{*6}
20 (14H)	Detailed motion control Signal Tower pattern (Tier 2)	High	00H: Do not control, 01H: Control
		Low	Detailed motion control. Refer to Signal Tower pattern (low) ^{*6}
21 (15H)	Detailed motion control Signal Tower pattern (Tier 3)	High	00H: Do not control, 01H: Control
		Low	Detailed motion control. Refer to Signal Tower pattern (low) ^{*6}
22 (16H)	Detailed motion control Signal Tower pattern (Tier 4)	High	00H: Do not control, 01H: Control
		Low	Detailed motion control. Refer to Signal Tower pattern (low) ^{*6}

***1 Signal Tower motion control: Signal Tower pattern (low)**

Value	Description
00H	Light off
01H	Light on
02H	Flashing (slow)
03H	Flashing (medium)
04H	Flashing (fast)
05H	Single flash
06H	Double flash
07H	Triple flash
08H	Pulse (bright and dark)
09H	No change
0AH	Right chase light
0BH	Left chase light

***2 Signal Tower motion control: Buzzer pattern (low)**

Value	Description
00H	Stop
01H	Buzzer pattern 1
02H	Buzzer pattern 2
03H	Buzzer pattern 3
04H	Buzzer pattern 4
05H	Buzzer pattern 5
06H	Buzzer pattern 6
07H	Buzzer pattern 7
08H	Disabled
09H	No change

***3 Detailed motion control: Signal Tower color (low)**

Value	Description
00H	Light off
01H	Red
02H	Amber
03H	Lemon
04H	Green
05H	Cyan
06H	Blue
07H	Purple
08H	Pink
09H	White

***4 Detailed motion control: Signal Tower pattern (low)**

Value	Description
00H	No flashing
01H	Flashing (slow)
02H	Flashing (medium)
03H	Flashing (fast)
04H	Single flash
05H	Double flash
06H	Triple flash
07H	Pulse (bright and dark)
08H	Right chase light
09H	Left chase light

***5 Detailed motion control: Buzzer pattern (low)**

Value	Description
00H	Stop
01H	Buzzer pattern 1
02H	Buzzer pattern 2
03H	Buzzer pattern 3
04H	Buzzer pattern 4
05H	Buzzer pattern 5
06H	Buzzer pattern 6
07H	Buzzer pattern 7

***6 Detailed motion control Signal Tower pattern (low)**

Value	Description
00H	No flashing
01H	Flashing (slow)
02H	Flashing (medium)
03H	Flashing (fast)
04H	Single flash
05H	Double flash
06H	Triple flash
07H	Pulse (bright and dark)
08H	Right chase light
09H	Left chase light

Point

- If each control operation is executed at the same time, it is executed in the following priority order.
 - Clear > Signal Tower motion control > Detailed motion control
 - When register address 17 (11H) "Signal Tower pattern (all tiers)" and register addresses 19 (13H) to 22 (16H) "Signal Tower pattern (1 to 4 tiers)" are used, register address 17 (11H) "Signal Tower pattern (all tiers)" has priority.
- When the clear is executed, the light is off and the buzzer is muted.
- All high data readings are set to 00H.

8.2.3. Example Mapping of Registers

Register Address	Register Number	Example data
1 (01H)	40001	Light on: 0101H=257 Flashing (slow): 0102H=258
2 (02H)	40002	Light on: 0101H=257 Flashing (slow): 0102H=258
3 (03H)	40003	Light on: 0101H=257 Flashing (slow): 0102H=258
4 (04H)	40004	Light on: 0101H=257 Flashing (slow): 0102H=258
5 (05H)	40005	–
6 (06H)	40006	Buzzer pattern 1: 0101H = 257 Buzzer pattern 2: 0102H = 258
7 (07H)	40007	–
8 (08H)	40008	Execute Clear: 0001H = 1
9 (09H)	40009	–
10 (0AH)	40010	–
11 (0BH)	40011	–
12 (0CH)	40012	Light on (Red): 0101H = 257 Light on (Amber): 0102H = 258
13 (0DH)	40013	Light on (Lemon): 0103H = 259 Light on (Green): 0104H = 260
14 (0EH)	40014	Light on (Cyan): 0105H = 261 Light on (Blue): 0106H = 262
15 (0FH)	40015	Light on (White): 0109H = 265 Light off: 0100H = 256
16 (10H)	40016	–
17 (11H)	40017	No flashing: 0100H = 256 Flashing (slow): 0101H = 257
18 (12H)	40018	Buzzer pattern 1: 0101H = 257 Buzzer pattern 7: 0107H = 263
19 (13H)	40019	No flashing: 0100H = 256 Flashing (slow): 0101H = 257
20 (14H)	40020	No flashing: 0100H = 256 Flashing (medium): 0102H = 258
21 (15H)	40021	No flashing: 0100H = 256 Flashing (fast): 0103H = 259
22 (16H)	40022	No flashing: 0100H = 256 Single flash: 0104H = 260

8.2.4. Example Transmission

● Read Holding Registers (03H)

Control Command

Transaction ID	Protocol ID	Field Length	Unit ID	Function Code	Data	
					Start Address ^{*1}	Number of Registers ^{*2}
00H 01H	00H 00H	00H 06H	01H	03H	00H 00H	00H 06H

*1 To get the status of the register addresses, specify "-1" of the start register address.

*2 Specify the number of the registers to get the status.

Response Command

- Signal Tower: "Tier 1: Light on", "Tier 2: Flashing (slow)", "Tier 3 and 4: Light off"
- Buzzer: When emit buzzer with "Pattern 1"

Transaction ID	Protocol ID	Field Length	Unit ID	Function Code
00H 01H	00H 00H	00H 0FH	01H	03H

Data						
Number of bytes	Register1	Register2	Register3	Register4	Register5	Register6
0CH	00H 01H	00H 02H	00H 00H	00H 00H	00H 00H	00H 01H

● Write Single Resister (06H)

Control Command

Signal Tower: When operating with "Tier 2: Flashing (medium)"

Transaction ID	Protocol ID	Field Length	Unit ID	Function Code	Data	
					Address ^{*1}	Register2 ^{*2}
00H 02H	00H 00H	00H 06H	FFH	06H	00H 01H	01H 03H

*1 To control register addresses, specify "-1" of the register address.

*2 Specify the status to control.

Response Command

Transaction ID	Protocol ID	Field Length	Unit ID	Function Code	Data	
					Address	Register2
00H 02H	00H 00H	00H 06H	FFH	06H	00H 01H	01H 03H

● Diagnostics (08H)

Control Command

Transaction ID	Protocol ID	Field Length	Unit Identifier	Function Code	Data	
					Diagnosis Sub Cod ^{*1}	Data ^{*2}
00H 03H	00H 00H	00H 06H	00H	08H	00H 00H	00H 00H

*1 Fixed to "00H 00H".

*2 Fixed to "00H 00H".

Response Command

When powered

Transaction ID	Protocol ID	Field Length	Unit Identifier	Function Code	Data	
					Diagnosis Sub Cod	Data*
00H 03H	00H 00H	00H 06H	00H	08H	00H 00H	00H 01H

* Response Data when powered: 00H 01H

● Write Multiple Registers (10H)

Control Command ①

- Signal Tower: "Tier 1: Light on", "Tier 2: Flashing (slow)", "Tier 3: No change", "Tier 4: Light off"
- Buzzer: When emit buzzer with "Pattern 2"

Transaction ID	Protocol ID	Field Length	Unit Identifier	Function Code
00H 04H	00H 00H	00H 13H	00H	10H

Data								
Start Address ^{*1}	Number of Registers ^{*2}	Number of bytes ^{*3}	Register1	Register2	Register3	Register4	Register5	Register6
00H 00H	00H 06H	0CH	01H 01H	01H 02H	00H 00H	01H 00H	00H 00H	01H 02H

*1 To control register addresses, specify "-1" of the start register address.

*2 Specify the number of registers to send.

*3 Specify the number of bytes in the register to send.

Response Command ①

Transaction ID	Protocol ID	Field Length	Unit Identifier	Function Code	Data	
					Start Address	Number of Registers
00H 04H	00H 00H	00H 06H	00H	10H	00H 00H	00H 06H

Control Command ②

Detailed motion control

- Signal Tower: "Tier 1: Red, Flashing (slow)", "Tier 2: Red, Flashing (slow)", "Tier 3: Cyan, Flashing (slow)", "Tier 4: Purple, Flashing (slow)"
- Buzzer: When emit buzzer with "Pattern 7"

Transaction ID	Protocol ID	Field Length	Unit ID	Function Code
00H 00H	00H 00H	00H 1DH	00H	10H

Data								
Start Address ^{*1}	Number of Registers ^{*2}	Number of bytes ^{*3}	Register12	Register13	Register14	Register15	Register16	Register17
00H 0BH	00H 0BH	16H	01H 01H	01H 01H	01H 05H	01H 07H	00H 00H	01H 01H

Data				
Register18	Register19	Register20	Register21	Register22
01H 07H	00H 00H	00H 00H	00H 00H	00H 00H

*1 To control register addresses, specify "-1" of the start register address.

*2 Specify the number of registers to send.

*3 Specify the number of bytes in the register to send.

Response Command ②

Transaction ID	Protocol ID	Field Length	Unit ID	Function Code	Data	
					Start Address	Number of Registers
00H 00H	00H 00H	00H 06H	00H	10H	00H 0BH	00H 0BH

Control Command ③

Detailed motion control

- Signal Tower: "Tier 1: White, No flashing", "Tier 2,:Red, Flashing (slow)", "Tier 3: Light off", "Tier 4: Cyan, Flashing (slow)"
- Buzzer: When emit buzzer with "Pattern 1"

Transaction ID	Protocol ID	Field Length	Unit ID	Function Code
00H 00H	00H 00H	00H 1DH	00H	10H

Data								
Start Address ^{*1}	Number of Registers ^{*2}	Number of bytes ^{*3}	Register12	Register13	Register14	Register15	Register16	Register17
00H 0BH	00H 0BH	16H	01H 09H	01H 01H	01H 00H	01H 05H	00H 00H	00H 00H

Data				
Register18	Register19	Register20	Register21	Register22
01H 01H	01H 00H	01H 01H	01H 00H	01H 01H

- *1 To control register addresses, specify "-1" of the start register address.
- *2 Specify the number of registers to send.
- *3 Specify the number of bytes in the register to send.

Response Command ③

Transaction ID	Protocol ID	Field Length	Unit ID	Function Code	Data	
					Start Address	Number of Registers
00H 00H	00H 00H	00H 06H	00H	10H	00H 0BH	00H 0BH

● Exception Response

List of exception responses from this product.

Code (Hex)	Function Name	Description
01H	Unsupported Function	Response when receiving an unsupported function code.
02H	Unsupported Data Address	Response when unassigned data address is specified.
03H	Unsupported Data Value	Response when unassigned data value is specified.

For an exception response, after a function code is received. 1 is set to its most significant bit (add 80H) and sent as a response.

Unsupported Function Code Commands

Transaction ID	Protocol ID	Field Length	Unit ID	Function Code	Data	
					Start Address	Number of Registers
12H 34H	00H 00H	00H 06H	12H	09H	00H 00H	00H 06H

Exception Response

Transaction ID	Protocol ID	Field Length	Unit ID	Function Code	Exception Code
12H 34H	00H 00H	00H 03H	12H	89H	01H

8.3. HTTP Commands

By sending HTTP commands, you can control this product and obtain the status of this product.

● HTTP Command Control

Parameter Name	Description
alert	Controls the each tier of the Signal Tower and controls the buzzer.
color	Controls the Signal Tower by specifying the color of each tier. (Make sure to specify "buzzer" at the same time)
buzzer	Specify the pattern of the buzzer and emit buzzer. (Make sure to specify "color" at the same time)
flash	Controls the all tiers of the Signal Tower. (Specify both "color" and "buzzer" at the same time)
flashe	Controls the each tiers of the Signal Tower. (Specify both "color" and "buzzer" at the same time)
clear	Turns off the Signal Tower and stops the buzzer.

● Get HTTP command status

Parameter Name	Description
format	Obtains the Signal Tower and buzzer status, software version, and MAC address in the specified format.

8.3.1. Controls HTTP Command

By sending HTTP commands, you can control this product's tiers and buzzer.

Item	Description
Protocol	HTTP
Method	GET
Syntax	http://<IP_address>/api/control?<parameter_name>=<value>[&<parameter_name>=<value>]
Response	Success.: The parameter name is correct.
	Error.: The parameter name is incorrect.

Parameter Name	Parameter	Values	Description
alert	alert = <integer value>	6 digits	Controls each tier of the Signal Towers and buzzers. Specify the pattern in the order of Tier 1, Tier 2, Tier 3, Tier 4, "0" (fixed), buzzer.
color	color = <integer value>	5 digits	Controls each tier of the Signal Towers by specifying colors. (Make sure to specify "buzzer" at the same time)
buzzer	buzzer = <integer value>	1 digit	Specify a pattern and emit the buzzer. (Make sure to specify "color" at the same time)
flash	flash = <integer value>	1 digit	Flashing the all tiers of the Signal Tower. (Specify both "color" and "buzzer" at the same time)
flashe	flashe = <integer value>	5 digits	Flashing individually for each tier of the Signal Tower. (Specify both "color" and "buzzer" at the same time)
clear	clear = <integer value>	1 digit	Lights off the Signal Tower and stops the buzzer.

Point

- Specify both "color" and "buzzer" at the same time. If you specify only "color" or only "buzzer", the send operation will not take place.
- When sending "flash" or "flashe", Make sure to specify "color" and "buzzer" at the same time.
- "flash" takes precedence over "flashe".
- The combinations of parameters that you can send simultaneously are as follows.
 - color&buzzer
 - color&buzzer&flash
 - color&buzzer&flashe

8.3.1.1. "alert" control

Parameter: alert=<integer value (6 digits)>

1	2	3	4	5	6
Signal Tower pattern Tier 1	Signal Tower pattern Tier 2	Signal Tower pattern Tier 3	Signal Tower pattern Tier 4	0 (Fixed)	Buzzer pattern

Type	Value	Description
Signal Tower pattern	0	Light off
	1	Light on
	2	Flashing (slow)
	3	Flashing (medium)
	4	Flashing (fast)
	5	Single flash
	6	Double flash
	7	Triple flash
	8	Pulse (bright and dark)
	9	No change

Type	Value	Description
Buzzer pattern	0	Stop
	1	Buzzer pattern 1
	2	Buzzer pattern 2
	3	Buzzer pattern 3
	4	Buzzer pattern 4
	5	Buzzer pattern 5
	6	Buzzer pattern 6
	7	Buzzer pattern 7
	8	Disabled*
	9	No change

* This will result in an error.

8.3.1.2. "color" control

Parameter: color=<integer value (5 digits)>

1	2	3	4	5
Signal Tower color Tier 1	Signal Tower color Tier 2	Signal Tower color Tier 3	Signal Tower color Tier 4	0 (Fixed)

Type	Value	Description
Signal Tower color	0	Light off
	1	Red
	2	Amber
	3	Lemon
	4	Green
	5	Cyan
	6	Blue
	7	Purple
	8	Pink
	9	White

8.3.1.3. "buzzer" control

Parameter: buzzer=<integer value (1 digit)>

Type	Value	Description
Buzzer pattern	0	Stop
	1	Buzzer pattern 1
	2	Buzzer pattern 2
	3	Buzzer pattern 3
	4	Buzzer pattern 4
	5	Buzzer pattern 5
	6	Buzzer pattern 6
	7	Buzzer pattern 7
	8	Disabled*
	9	No change

* This will result in an error.

8.3.1.4. "flash" control

Parameter: flash=<integer value (1 digit)>

Type	Value	Description
Signal Tower pattern	0	No flashing
	1	Flashing (slow)
	2	Flashing (medium)
	3	Flashing (fast)
	4	Single flash
	5	Double flash
	6	Triple flash
	7	Pulse (bright and dark)
	8	Right chase light
	9	Left chase light

8.3.1.5. "flashe" control

Parameter: flash=<integer value (5 digits)>

1	2	3	4	5
Signal Tower pattern Tier 1	Signal Tower pattern Tier 2	Signal Tower pattern Tier 3	Signal Tower pattern Tier 4	0 (Fixed)

Type	Value	Description
Signal Tower pattern	0	No flashing
	1	Flashing (slow)
	2	Flashing (medium)
	3	Flashing (fast)
	4	Single flash
	5	Double flash
	6	Triple flash
	7	Pulse (bright and dark)
	8	Right chase light
	9	Left chase light

8.3.1.6. "clear" control

Parameter: clear=<integer value (1 digit)>

Type	Value	Description
Clear	1	Execute Clear

8.3.1.7. Example Transmission

● alert

- Signal Tower: "Tier 1: Light on", "Tier 2 and 3: Flashing (slow)", "Tier 4: Light off"
- Buzzer: Pattern 1

<http://192.168.10.1/api/control?alert=122001>

● color&buzzer

- Signal Tower: "Tier 1: Green", "Tier 2: Blue", "Tier 3: Light off", "Tier 4: White"
- Buzzer: Pattern 7

<http://192.168.10.1/api/control?color=46090&buzzer=7>

● color&buzzer&flash

- Signal Tower: "Tier 1: Green, Flashing (slow)", "Tier 2: Blue, Flashing (slow)", "Tier 3: Light off", "Tier 4: White, Flashing (slow)"
- Buzzer: Pattern 1

<http://192.168.10.1/api/control?color=46090&buzzer=1&flash=1>

● color&buzzer&flashe

- Signal Tower: "Tier 1: Green, No flashing", "Tier 2: Blue, Flashing (slow)", "Tier 3: Red, No Flashing", "Tier 4: White, Pulse (bright and dark)"
- Buzzer: Pattern 2

<http://192.168.10.1/api/control?color=46190&buzzer=2&flashe=01070>

● clear

To turn off the Signal Tower and stop the buzzer

<http://192.168.10.1/api/control?clear=1>

8.3.2. Get HTTP command status

By sending HTTP command, you can check the Signal Tower and buzzer status, and also the software version.

Item	Description	
Protocol	HTTP	
Method	GET	
Syntax	http://<IPAddress>/api/status?<parameter_name>=<value>	
Response	Response data in text and JSON format	When the parameter name is correct.
	Error.	When the parameter name is incorrect.

Parameter Name	Parameter	Values	Description
format	format = <string>	text, json	Returns the current status of the Signal Tower in the specified format. text: data in text format, json: data in JSON format Specify the pattern in this order: Tier 1, Tier 2, Tier 3, Tier 4, Buzzer

● Available data

Item	Header	Description	Data type (JSON format)
Status of Signal Tower Control	Status1 to 5	Indicates the control status (pattern) of the Signal Tower.*1	(Decimal)
Light color Information	Color1 to 5	Indicates Signal Tower light color information.*2	String
Buzzer control state	Buzzer Pattern	Indicates buzzer control status.	(Decimal)
Main unit firmware	Firmware Version	Indicates the firmware version. □ . □ □ ↑ 0-9	String
MAC Address	MAC Address	Indicates the MAC address of this product. □ : □ : □ : □ : □ : □ ↑ 00H-ff H	String

*1 Status5 is 0 (fixed).

*2 Color5 is #000000 (fixed).

● **Signal Tower control status (pattern)**
⇒ Displays in decimal

Type	Value	Description
Signal Tower pattern	0	Light off
	1	Light on
	2	Flashing (slow)
	3	Flashing (medium)
	4	Flashing (fast)
	5	Single flash
	6	Double flash
	7	Triple flash
	8	Pulse (bright and dark)
	10	Right chase light
	11	Left chase light

● **Light on color information**
⇒ Displays with string

Type	Value			Description
	Color (R)	Color (G)	Color (B)	
Signal Tower color	FF	00	00	Red
	FF	CC	00	Amber
	EE	FF	00	Lemon
	00	FF	00	Green
	00	BB	DD	Cyan
	00	33	FF	Blue
	CC	00	DD	Purple
	FF	00	CC	Pink
	FF	FF	FF	White

● **Buzzer control status**
⇒ Displays in decimal

Type	Value	Description
Buzzer pattern	00	Stop
	01	Buzzer pattern 1
	02	Buzzer pattern 2
	03	Buzzer pattern 3
	04	Buzzer pattern 4
	05	Buzzer pattern 5
	06	Buzzer pattern 6
	07	Buzzer pattern 7

● **Obtained data format specifications**

Line feed code	LF
Indent	4 single-byte spaces
Character code	UTF-8

● Example of command transmission and obtained data

- MAC address of this product: "80:39:E5:00:1A:2F"
- Signal Tower: "Tier 1: Red, Light on", "Tier 2: Amber, Light on", "Tier 3: Green, Light on", "Tier 4: Blue, Light on"
- Buzzer: Pattern 1
- Firmware version: "1.00"

```
<text>
Transmission Command
http://192.168.10.1/api/status?format=text
```

```
Obtained data
Status1: 1
Status2: 1
Status3: 1
Status4: 1
Status5: 0
Color1: #FF0000
Color2: #FFCC00
Color3: #00FF00
Color4: #0033FF
Color5: #000000
Buzzer Pattern : 1
Firmware Version: 1.00
MAC Address: 80:39:e5:00:1a:2f
```

```
<json>
Transmission Command
http://192.168.10.1/api/status?format=json
```

```
Obtained data
{
  "Unit_Status": [1, 1, 1, 1, 0],
  "Unit_Color": ["#FF0000", "#FFCC00", "#00FF00", "#0033FF", "#000000"],
  "Buzzer_Pattern": 1,
  "Firmware_Version": "1.00",
  "MAC_Address": "80:39:e5:00:1a:2f"
}
```

9. Maintenance

9.1. Initialization Method

This product can be initialized in two methods. For information about the items that can be initialized, refer to the table below.

Initialization Method	Change language	Main unit settings	Network Settings	Command Reception Settings	Modbus/TCP	Password
Set button	●	●	●	●	●	●
Web Setup Screen	●	●	X	●	●	●
	●	●	●	●	●	●

● : Initialized items, X : Non-initialized Items

9.1.1. How to Initialize with the "Switch for Initialize"

The "Switch for Initialize" is located inside the cover. For details, refer to "4. Part Names and Dimensions" (☞ page 11).

⚠ CAUTION

- ⊘ Do not press the "Switch for Initialize" too hard. Failure to follow this instruction could result in equipment damage.
- ⊘ Do not use excessive force operation on "Switch for Initialize". Failure to follow this instruction could result in deformed frame and product damage.
- ⊘ Do not use sharp tipped objects with this product. Operation may become impossible as scratches develop on "Switch for Initialize" and switch contacts are interfered with.

- 1** Remove the cover.
- 2** Press the "Switch for Initialize" more than 3 seconds.
 - Press and hold the "Switch for Initialize" more than 3 seconds using a non-conductive tool (e.g., ceramic screwdriver) with a diameter of about 2 mm.
→ Status lamp flash.
- 3** Status lamp flashes.
 - When the status lamp flashes, initialization is complete. Stop pressing the "Switch for Initialize".
 - When the initialization is completed, the system restarts with the factory defaults. For the contents of each item setting in the factory default state, refer to "● Initial values of each item after initialization (factory default)" (☞ page 68)

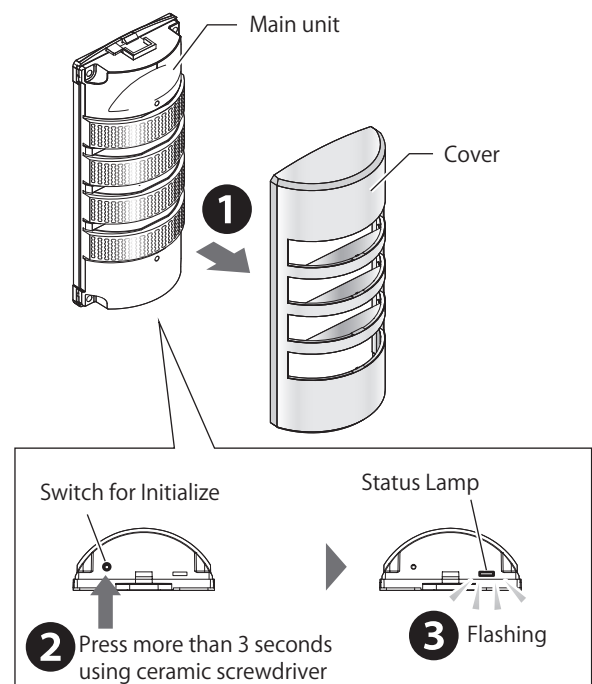

9.1.2. Initialize from the Web Setup Screen

⚠ CAUTION

⚠ If you initialize with the "Initialize the network" check box selected, this product's network settings revert to the default settings.
To use it again, you need to reconfigure the network.

1 Log in to the Web Setup Screen.

- "7.3. Displaying the Web Setup Screen" (👉 page 27)

2 From the menu, click "Initialization".

- Select the "Initialize the network" check box to also initialize the network settings.

3 Click the "Initialize" button.

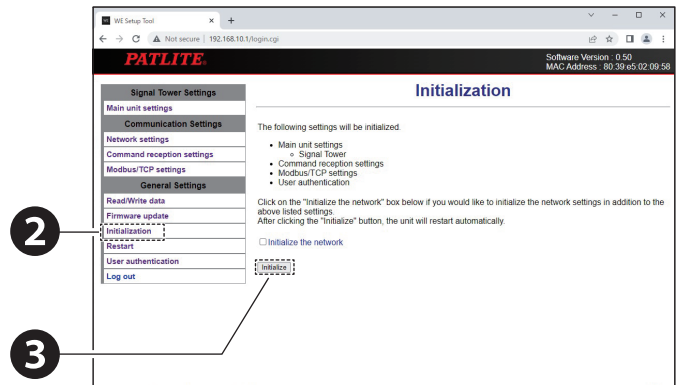

4 When "Rebooting unit." is displayed, click "To the Login screen" to return to the login screen.

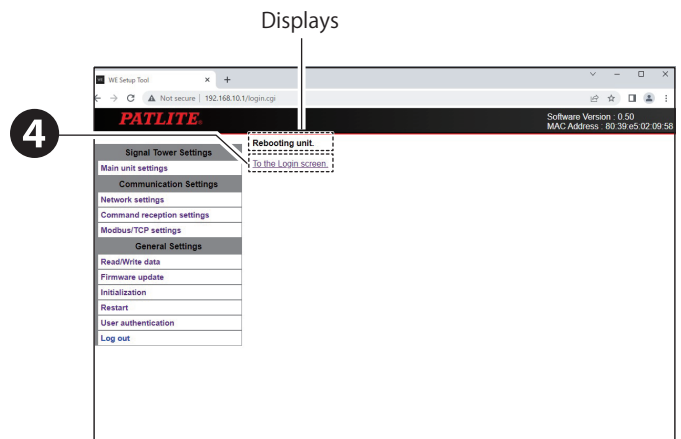

Point

- After initialization, the password is not set and the password setting screen will appear when you access the Web screen next time.
- Initial values of each item after initialization (factory default)

Item				Default Value
Signal Tower Settings	Main Unit Settings	Signal Tower	Tier 1	RED
			Tier 2	AMBER
			Tier 3	GREEN
			Tier 4	BLUE
		Buzzer	Buzzer volume	2: Maximum
Communication Settings	Network Settings	Setting Method		Set up manually
		IP Address		192.168.10.1
		Subnet Mask		255.255.255.0
		Default Gateway		0.0.0.0
		Host Name		we
	Command Reception Settings	Port number		10000
		Protocol		TCP
Modbus/TCP Setup	Port number		502	

9.2. Restarting Method

Use the Web setup screen to restart this product.

1 Log in to the Web Setup Screen.

- "7.3. Displaying the Web Setup Screen" (👉 page 27)

2 From the menu, click "Restart".

3 Click the "Restart" button.

4 When "Rebooting unit." is displayed, click "To the Login screen" to return to the login screen.

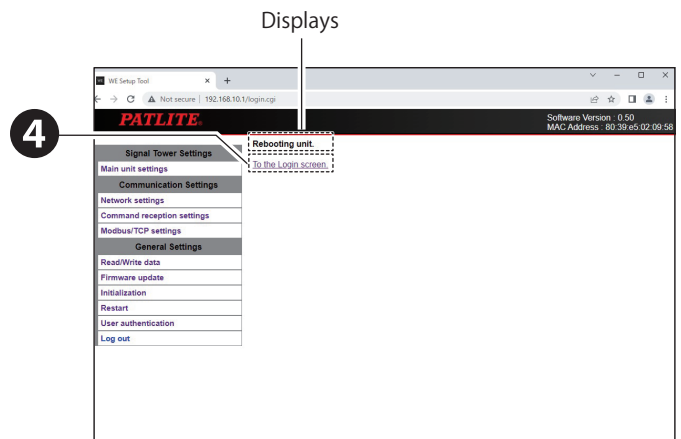
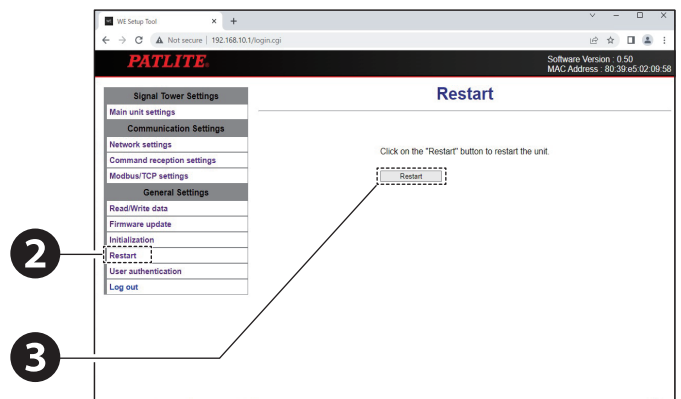

9.3. How to change Web Login Password

You can change the password in the Web Setup Screen. Changing the password also on the Web setup screen.

1 From the Menu, click "User authentication" to enter the "User authentication" settings screen.

2 In the "User authentication" screen, enter the new password in the password field.

- Input characters: 1 to 16 single-byte alphanumeric characters
- * Password characters are case-sensitive.

3 Re-enter the new password in the "Verify Password" field.

4 Click the "Confirm" button.

- Click "Confirm" and the entered value is now the new password.

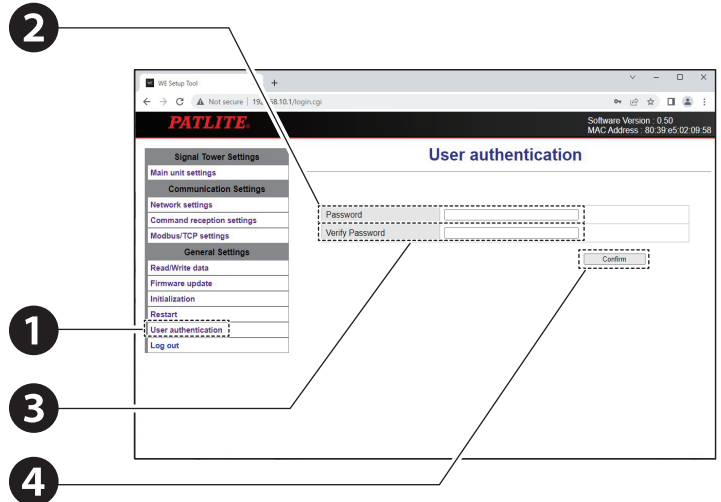

9.4. How to check the Version

You can check the firmware version of this product in the following two methods.

- Check the version from the Web Setup Screen
- Check with the "Get HTTP command status"

● Check the version from the Web Setup Screen

1

Log in to Web setup screen of this product.

- The firmware version is displayed in the upper right corner of the screen.
- The MAC address of this product is displayed at the bottom of the firmware version.

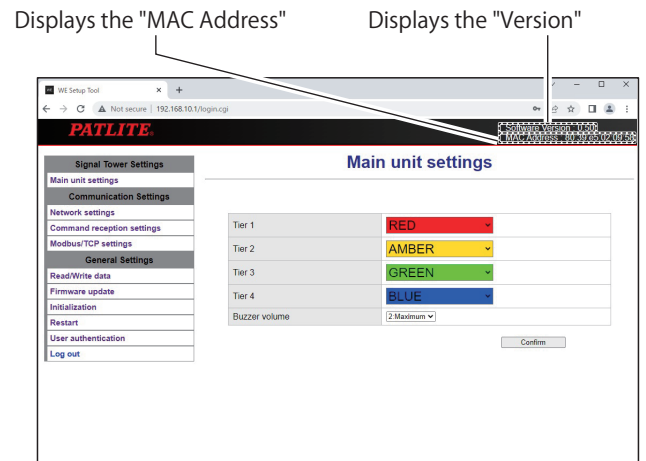

● Check with the "Get HTTP command status"

For information, refer to "8.3.2. Get HTTP command status" (👉 page 63).

9.5. How to update the Firmware

You can update the firmware of this product on the Web set up screen.

CAUTION

- ⊘ After clicking "Update", do not interact with the browser until firmware update is complete.
- ⊘ While updating, do not turn off the power for this product. Also do not disconnect the power supply wire or LAN cable. Failure to follow this instruction could result in product damage.
- ⚠ Before updating, check the firmware version and compatible models. Performing updates with firmware that is not compatible with this product could result in equipment damage.

1 Log in to the Web Setup Screen.

2 From the menu, click "Firmware update".

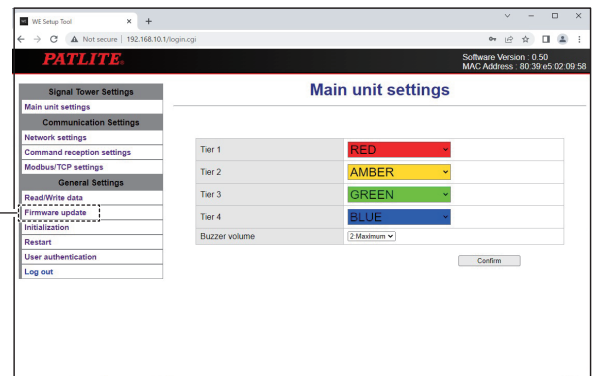

3 Click "Choose File" and select the firmware to be updated.

4 Click "Update".

- Click "Update" to start updating the firmware.
- After update is complete, this product automatically reboots.

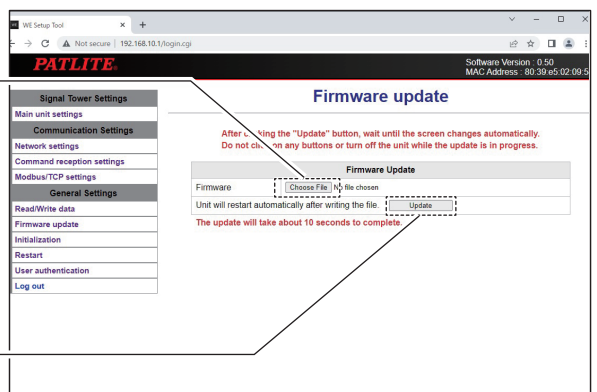

10. Troubleshooting

10.1. Troubleshooting

Issue	Checklist	Reference
Power does not turn on	Is the power supply applied at the correct voltage? Check that the power supply is applied at the rated voltage.	"6.3. Wiring Method" (☞ page 19)
Cannot automatically get IP address, does not start in DHCP mode	At startup, if access to the DHCP server is unavailable, this product uses its default value 192.168.10.1 in the network settings. Check if the environment supports connecting to the DHCP server.	-
	Is allocation of IP addresses set to "Manual Settings"? Change the setting method to "Automatic Settings".	"7.4. Setting Up Product Network Settings" (☞ page 29)
The Web Setup Screen does not display or does not display correctly	Is the LAN cable connected? Check if the LAN cable is connected properly.	"6.3. Wiring Method" (☞ page 19)
	Is the LAN cable rated Category 5e or higher? Use LAN cables rated for Category 5e or higher.	"6.3. Wiring Method" (☞ page 19)
	Is the IP address for the product correct? Check the IP address of the product.	"7.3. Displaying the Web Setup Screen" (☞ page 27) "7.4. Setting Up Product Network Settings" (☞ page 29)
	Is the IP address for the product duplicated on other equipment? Check the IP address of the product.	
	Are you accessing the correct IP address? Check the IP address of the product.	
	Is the IP address on the personal computer correct? Check the personal computer settings.	"7.1. Setting Up Network Settings on the PC" (☞ page 22)
	Check the browser you are using. Use either Google Chrome or Microsoft Edge.	-
	In the browser security settings, is JavaScript disabled? Enable running JavaScript in the browser.	-
	Check operation after deleting the browser history.	-
	You may be viewing browser cache data. Please try either of the following methods. <ul style="list-style-type: none"> • After logging out of the Web setup screen, log in again to check the display of cache data. • Clear the browser cache, refresh the Web settings screen, and check the display of cached data. *The method for clearing the browser cache varies depending on the browser used. Follow the clearing method of your browser.	-

Issue	Checklist	Reference
Logging in to the Web Setup Screen causes an error to display	Are you accessing the correct IP address? Check the IP address displayed in the browser's address field.	-
Socket communication is not possible	Is the communication port correct? Check the "Port number" setting.	"7.6. Setting Up Command Reception Settings" (☞ page 31)
	Is the communication command protocol correct? Check the communication command protocol you are using.	"7.6. Setting Up Command Reception Settings" (☞ page 31)
	Is the transmission data correct? Check the transmission data settings.	"8.1. PNS Commands" (☞ page 36) "8.2. Modbus/TCP" (☞ page 48) "8.3. HTTP Commands" (☞ page 57)
	Are you sending to the product address? Check the IP address of the product.	"7.3. Displaying the Web Setup Screen" (☞ page 27) "7.4. Setting Up Product Network Settings" (☞ page 29)
	Check the settings of the source equipment and of communication equipment on the transmission route to confirm communication is not blocked by a firewall, filtering, port blocking function, and so on.	-
Different operation from the command sent	Is this product receiving Modbus/TCP commands? Check the equipment that is sending Modbus/TCP commands to this product.	"8.2. Modbus/TCP" (☞ page 48)
LED does not light up or flash	Is the power supply applied at the correct voltage? Check that the power supply is applied at the rated voltage.	-
	Is "BLACK" selected for the Signal Tower color? Set a light on color.	"7.5. Setting Up Main Unit" (☞ page 30)
There is no buzzer sound	Is the buzzer volume set to "0 (Mute)"? Set the buzzer to the desired volume.	"7.5. Setting Up Main Unit" (☞ page 30)
	Is the power supply applied at the correct voltage? Check that the power supply is applied at the rated voltage.	-
Failed to write the setup data	Is the setting data writing correctly? Check the writing setting data is correct.	"7.9. Writing the Setup Data" (☞ page 34)
Failed to write the firmware	Is it writing the correct firmware? Check if it is writing the correct firmware.	"9.5. How to update the Firmware" (☞ page 72)

11. Replacement Parts

Various parts are available to the customer for exchange or replacement.

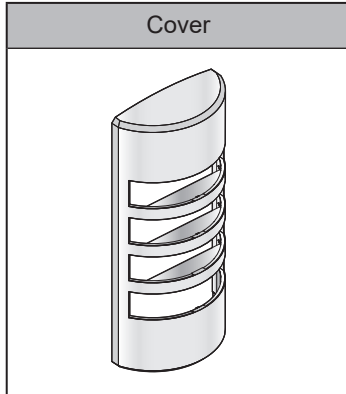

12. Specifications

Rated Voltage		24V DC
Operating Voltage Range		Rated Voltage \pm 10%
Rated Current Consumption	Max.	230 mA
Rated Power Consumption	Max.	5.5 W
Operating Ambient Temperature		-10°C to +55°C
Operating Ambient Humidity		Less than 85% RH (No freezing, no condensation)
Storage Ambient Temperature		-10°C to +60°C
Storage Ambient Humidity		Less than 85% RH (No freezing, no condensation)
Mounting Location		Indoor / Wall mounting
Mounting Direction		Upright
Protection Rating		IP23 (IEC 60529) *Excluding mounting screws
	Environmental	Wall mount / Upright
Insulation Resistance		More than 1M Ω at 500 VDC between live part and non-current carrying metallic part
Withstand Voltage		500 VAC applied for 1min between live part and non-current carrying metallic part without breaking insulation
Luminous part	Number of Signal Tower tiers	4 tiers
	Luminous colors	9 colors
	Flashing pattern	10 patterns
Buzzer part	Buzzer pattern	7 patterns
	Sound Pressure Level	Typ. 88 dB (approximately -10 dB with sound reduction)
	Environmental	Maximum volume, Buzzer pattern 2, Wall-mounted, measured from the front direction of the buzzer aperture at 1 m
Mass (Tolerance: \pm 10%)		420 g
Outer Dimensions		"4. Part Names and Dimensions" ( page 11)
Interfaces	Power Supply Input	UL1061 AWG24 x 2 (24 VDC, GND)
	Ethernet	RJ-45 connector (female)

Network Communication Format	Ethernet (IEEE802.3 compliant) 10BASE-T/100BASE-TX (Auto-MDI/MDIX)
Status Lamp	LED x 1 (Install in the bottom of the main unit)
Lever	Switch for Initialize x 1 (located on the bottom of the main unit, can be operated when the cover is removed)
Accessories	<ul style="list-style-type: none">• Screw (+ Pan head screw) (M4 x 25) x 4• Plain Washer (ϕ 4 x 8 x 0.5) x 4• Flange nut (M4) x 4
Optional Parts	None
Remarks	Due to the characteristics of LED elements, there may be variations in the color tone and brightness of LED products.

PATLITE Corporation G2J

PATLITE Corporation ※Head office	■ www.patlite.com/
PATLITE (U.S.A.) Corporation	■ www.patlite.com/
PATLITE Europe GmbH ※Germany	■ www.patlite.eu/
PATLITE (SINGAPORE) PTE LTD	■ www.patlite-ap.com/
PATLITE (CHINA) Corporation	■ www.patlite.cn/
PATLITE KOREA CO., LTD.	■ www.patlite.co.kr/
PATLITE TAIWAN CO., LTD.	■ www.patlite.tw/
PATLITE (THAILAND) CO., LTD.	■ www.patlite.co.th/
PATLITE MEXICO S.A. de C.V.	■ www.patlite.com.mx/